

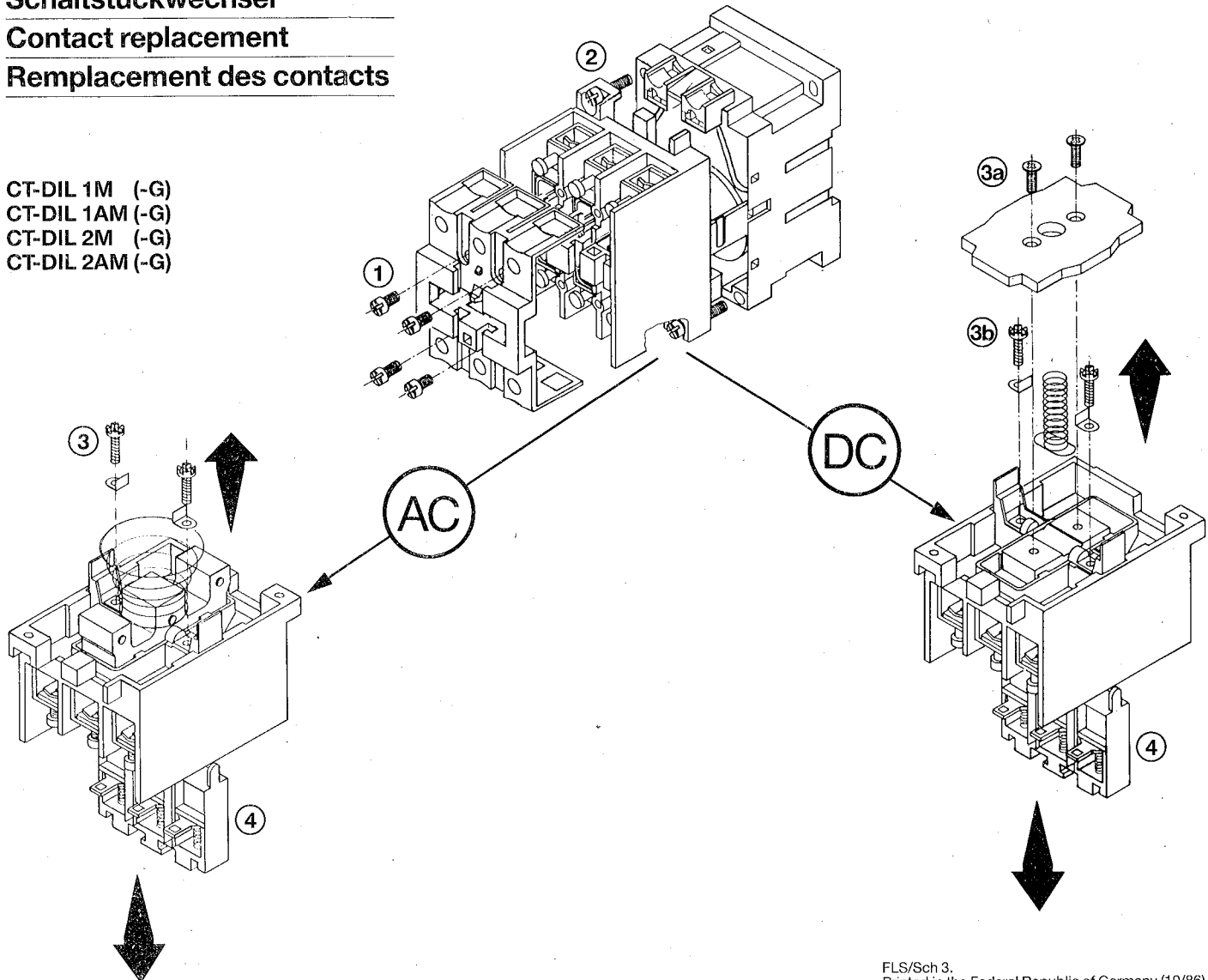

10/86 AWA 21-670

Schaltstückwechsel Contact replacement Remplacement des contacts

CT-DIL 1M (-G)
CT-DIL 1AM (-G)
CT-DIL 2M (-G)
CT-DIL 2AM (-G)



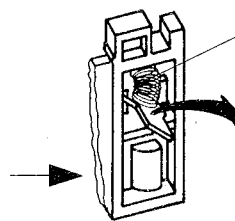
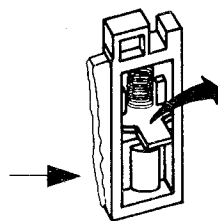
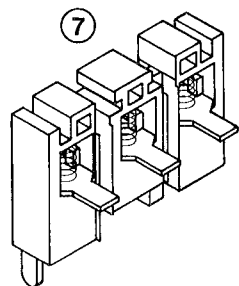
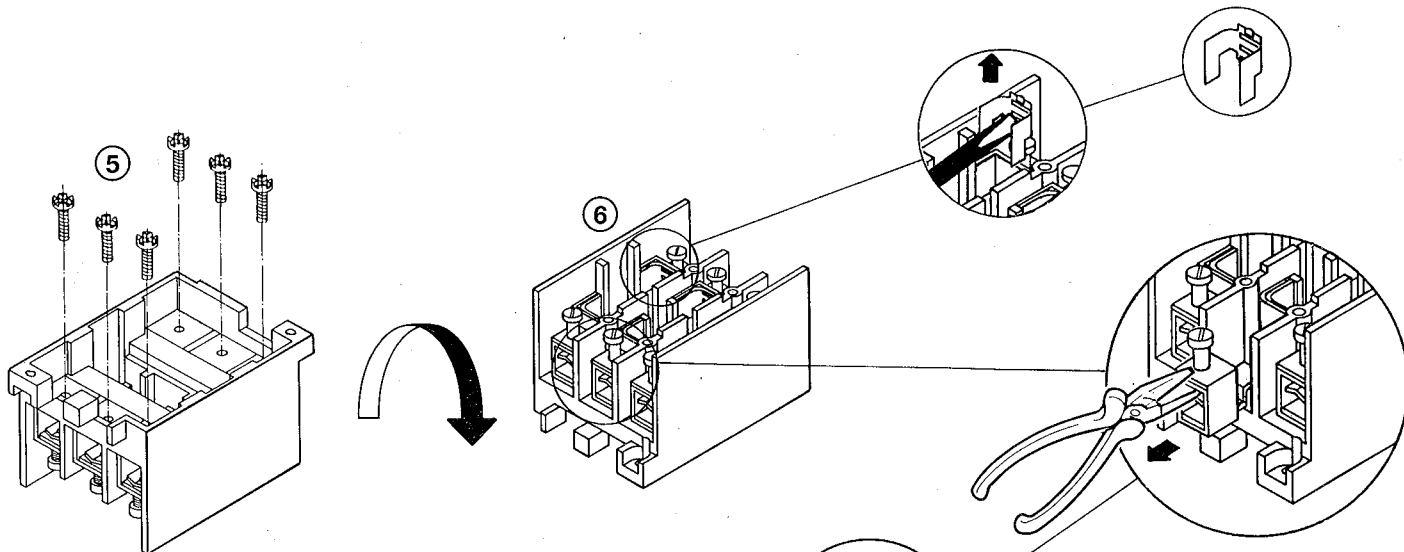

Feder sichern!
Secure springs
Bloquer les ressorts

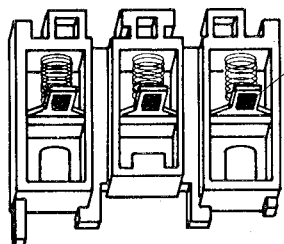
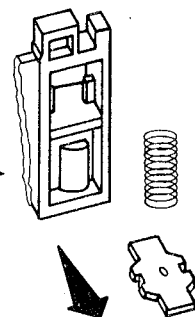

Achtung!!
Lage des Kontaktmaterials beachten
Caution:
Check location of contact material
Attention à la position des contacts

8 **Montage in umgekehrter Reihenfolge**
Reverse sequence to assemble
Pour remonter l'appareil, effectuer les
mêmes opérations dans l'ordre inverse

9 **Funktion prüfen!!**
Check operation!!
Vérifier le fonctionnement!!