

xStart: Efficient solutions for motor control



xStart

The complete range of contactors, efficient motor-starters and variable speed drives for the motor circuit. New simple to install solutions based on clever communication.

DIL contactors

PKZ motor-protective circuit-breakers

MSC motor-starters

DS 4 softstarters

DF & DV Drives

Rapid Link

Product information
DIL M motor contactors
PKZ motor-protective circuit-breakers
MSC motor-starters

MOELLER 

Think future. Switch to green.

For Immediate Delivery call KMParts.com at (866) 595-9616

**xStart is the intelligent solution:
easier engineering, faster fitting**



Both trade and industry expect innovations in electrical engineering to bring them clear advantages by making processes more efficient – all the way from the planning stage through engineering to fitting and installation. The new xStart range from Moeller does just that.

“We need a partner we can rely on. Moeller satisfies all of our needs.”



With Moeller you can meet any challenge!

Moeller has proved its competence as a partner with high-quality, efficient motor-related solutions for more than a century. xStart now offers you the complete range of products needed for switching, protecting, starting, running up and controlling motors. You can rely on our competence in each of these areas, and we can meet any challenge from contactors to drive control.

- 1 The latest innovation is the new MSC motor-starter: a combination of standard components, i.e. the new DIL M motor contactors and the optimised PKZ motor-protective circuit-breakers.

Just four slim starter modules up to 150 A, each with the same dimensions for AC and DC, significantly simplify planning and engineering.

- 2 The newly developed DIL M motor contactors can switch motors up to 150 A. Their significantly improved performance criteria such as pick-up and sealing consumption, space saving foot-prints and ease of installation make these contactors state-of-the-art, top-class product.

Tested quality

Every single one of our products is built and tested to the latest national and international standards. Having attained all the major approvals, they are perfectly suited to the world's market.



PKZ motor-protective circuit-breakers: now better than ever

Now up to 32 A!
150 kA up to 12 A!
50 kA up to 32 A!



PKZ motor-protective circuit-breakers from Moeller have long set the benchmark for quality. And now, for inclusion in the xStart concept, these products have been updated once again, and enhanced in terms of their technical specification.

The PKZM 0 now switches motors up to 32 A. At the same time, its short-circuit switching capacity is significantly increased: the short-circuit rating (400 V) is now 150 kA up to 12 A and 50 kA up to 32 A. The PKZM 4 also has a switching capacity of 50 kA. This simplifies the engineering of safety and reliability, with current limiters becoming virtually obsolete. PKZM 01 is a completely new product with push-button operation for switching motors up to 16 A (50 kA/400 V).

“PKZ motor-protective circuit-breakers are, and always will be, the epitome of safety, reliability and quality in motor protection.”





Common accessories throughout the system

Whether PKZM 0, PKZM 01 or PKZM 4, the accessories are always the same. Whether On or Off, overload or short circuit, differential indication helps to locate the cause of tripping without delay, every time. The auxiliary contacts can be fitted without tools and are fail-safe in the way they signal every switching state. One particularly convenient component is the NHI-E front auxiliary contact that can be optionally built into already installed and wired circuit-breakers. It goes without saying that all the auxiliary contacts and releases are worldmarket devices, for all the customary mains voltages.

- 4 The optionally integrable front auxiliary contact indicates the switching position of 1 NO and NC contact or 1 NO contact
- 5 Trip-indicating contacts: two contacts provide differential indication of short circuit or overload
- 6 Standard auxiliary contacts with up to three contacts for the On/Off switching position

The door coupling handle (IP 65) has a tripped position in addition to the On and Off positions.

PKZM 01 motor-protective circuit-breakers: easy to operate by pressing or hitting a button

The new PKZM 01 motor-protective circuit-breakers for motors up to 12 A are ideally suited to small machines and applications where operation by pressing or even hitting a button is preferred. In addition to the auxiliary contacts from the PKZM 0 range, special enclosures with ingress protection IP 65 or IP 40 and the appropriate Emergency-Stop buttons are available for these new components. Their short-circuit switching capacity is 50 kA.

- 1 Shunt trips and undervoltage trips
- 2 PKZM 0 motor-protective circuit-breakers from 0 to 32 A
- 3 PKZM 4 motor-protective circuit-breakers from 10 to 65 A



AC and DC contactors: both the same frame size – simplifies engineering

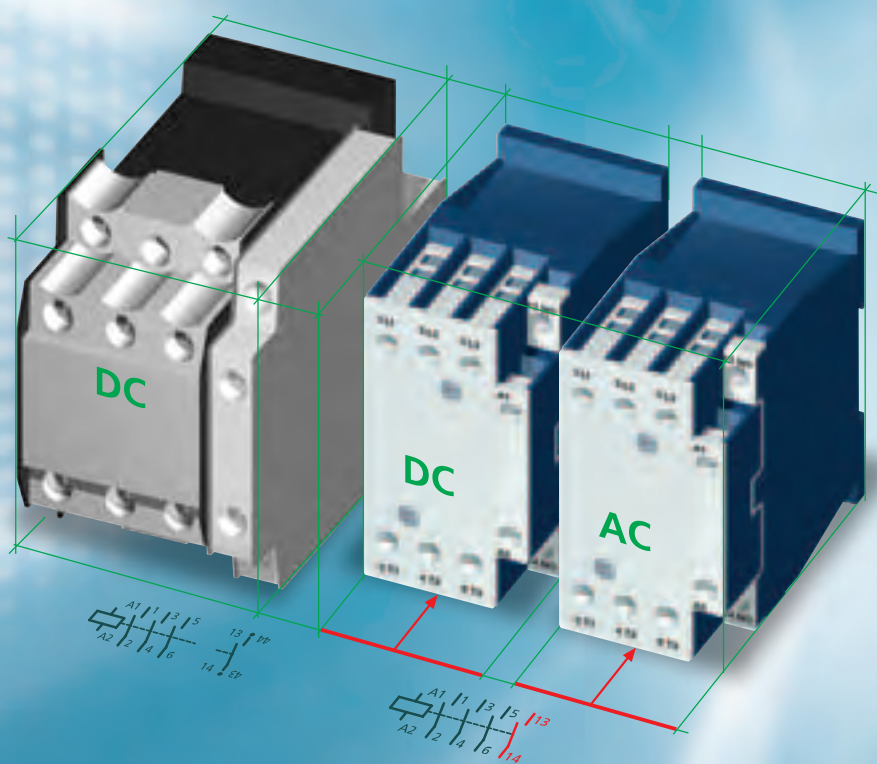

Great efficiency in planning and engineering with AC and DC contactors is achieved by them being the same dimensions. With only four component sizes covering the rating range up to 150 A engineering is further simplified.

Definitely useful: up to 32 A, the auxiliary contact is already built in, and the DC contactors include a suppressor circuit up to 150 A. From 12 A, the DC contactors have an electronic drive that removes the need for coupling relays. With all these extras already included in the contactors, your costs are clearly reduced.

DC contactors now are no bigger than AC contactors

The new DIL contactors are significantly more compact than their predecessors, even though, up to 32 A, the auxiliary contact is included. The advantage of this is particularly striking with the DC contactors that now are the same size as their AC counterparts. This makes everything easier, i.e. planning, engineering and fitting, without having to alter the control system, even if the control current has to change for another customer.



“With these new motor contactors, Moeller is definitely on to a winner. They bring real advantages from the planning all the way to the fitting costs.”

1 This reduces the cost of your control panel

The space-saving is achieved not just by the reduced component dimensions, but also due to the lower heat dissipation that, particularly with the DC contactors, helps keep the cabinet size down and saves the cost of a fan. The significantly reduced sealing consumption achieved by innovative, electronic drives makes this possible. The Moeller DC contactors from 17 up to 65 A have

a sealing consumption of only 0.5 Watt, even those at 150 A only use 1.5 Watt. This also results in lower power consumption for the whole installation.

2 No compromise where termination reliability is concerned

DIL contactors up to 150 A have box terminals with two clamping chambers, allowing unequal cable cross-sections to be terminated absolutely securely, even in strongly vibrating machines. This makes wiring easier and cuts down on associated errors.

3 The benefits of the electronically controlled drive

All DC motor contactors from DIL M17 have an electronically controlled drive that offers the following advantages:

- Significantly less heat dissipation due to reduced sealing consumption
- Smaller control transformers because of lower pick-up consumption
- Direct actuation from the PLC without coupling contactors.

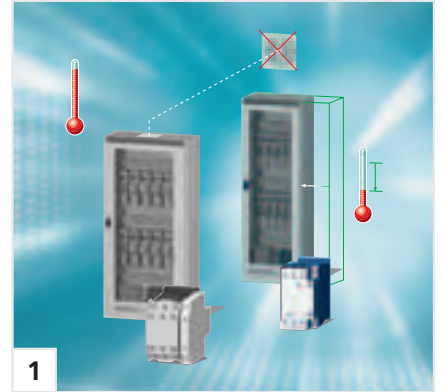

1

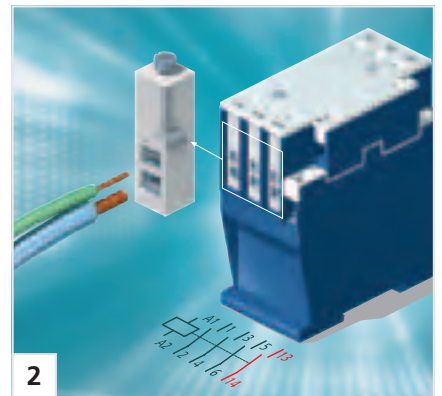

2



3



4



5

4 The new DIL A auxiliary contacts perfectly complement the new DIL M motor contactors.

5 Z overloads relays protect the motor against phase failure or overload. Their auxiliary contacts switch the motor contactor off, and signal the fault. These relays are suitable for protecting EEx e-motors according to ATEX 100 a guideline.

**The simplicity of it! –
Toolless plug connection!**



Using the new xStart motor-starter combinations it is possible to create the best solutions from standard products even more easily and efficiently.

Moeller has optimised the DIL and PKZ standard products in such a way that, by using simple toolless plug connectors, they can be assembled to form reliable motor-starters. Without the need for tools! The MSC motor-starter combinations can also be supplied as complete devices. Costs for fitting and wiring can be considerably reduced in this way. Costs for testing are cut and errors are prevented from the start. Another advantage lies in increased safety during maintenance work where removal of the combination plug connector produces a visible isolating gap. This Moeller technology is available on our direct-on-line and reversing starters up to 15.5 A.

“The toolless plug connection is very quick to fit – just what I need to reduce costs.”



Slim solutions: DOL starters from standard components

The new direct-on-line starters built from standard components are available in four slim frame sizes. The contactor and the protective switch are of the same compact width dimension. Thus you lose not a millimetre of control panel space. The convenient MSC motor-starters using toolless plug connection technology are available up to 15.5 A and require only a top-hat rail for mounting. The mechanical connector ensures a secure hold and the electrical connector provides optimum reliability and safety. Complete mounting connectors are offered for DOL and reversing starters from 17 up to 32 A. This prevents fitting errors and cuts down on wiring time.

Plug and go: reversing starters from standard components

The reversing starters offer distinct advantages to the assembler. Instead of laboriously having to tighten up 23 screws, a small number of components simply plug together. This of course speeds up fitting work, and means fewer errors and a very clearly laid out switching installation.

Speedier wiring using spring-loaded terminations

Moeller provides proven quality with tension clamp terminals. Numerous tests have proved that contactors and motor-protective circuit-breakers are just as securely wired in this way as by screw connection – even in strongly vibrating machines. But wiring work using tension clamp terminals is very much quicker to do. The main current paths on PKZM 0 and motor contactors up to 12 A all use spring-loaded terminals. The sundries for termination are always available for both screw and tension clamp connection.

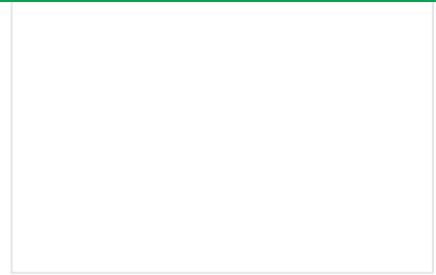

Reversing starters with mechanical interlock – as compact as it gets!



Reversing starters and star-delta combinations up to 15.5 A can be combined without tools.

Moeller has significantly reduced the wiring costs with reversing and star-delta combinations using tool-less plug connections. Moeller DIL M contactors up to 15.5 A feature sockets in which the connection elements are simply plugged in as standard and without additional expense. Thus, costs associated with operations such as cutting wires to length, stripping of insulation, work on the wire ends and provision of conductors with markings, as well as application of defined torques when tightening screws, have been totally eliminated. Inspection of 21 electrical connections between the mains and the star and delta contactor are reduced to a simple visual inspection. A measurement with test device probes can be undertaken without having to remove the connection elements.



Precious space is provided in the control panel by the narrow widths of just 55 mm on contactors up to 65 A. The mechanical interlocks which are usually found on reversing contactor combinations do not require any additional space from Moeller. The smart, patented solution is a plastic sphere. It is simply inserted into the side cavities provided on both contactors and reliably prevents simultaneous switch on. Furthermore, a lateral clearance between the contactors is not required – the contactors can be mounted and wired side-by-side. Generally, DC contactors in the range up to 65 A have a longer depth than AC contactors. However, with xStart – thanks to electronically supported magnet systems – all dimensions of the DC variants are identical to those

of the AC variants. If the manufacturer of mass produced machines uses differing control voltages, the testing of the control panel layout is now eliminated, the DC contactors are simply positioned on the top-hat rail or mounting plate in the same manner as the AC variants. The heat dissipation limits the packing density in control panels. Solutions which are possible from a purely mechanical viewpoint cannot be implemented due to heat dissipation considerations. The extremely low holding power of just 0.5 W with Moeller DC contactors now enables solutions which were previously impossible.



Mounting rail adapter with new flexibility

The switchgear interconnected with the three phase commoning links is generally snapped onto a mounting rail. The result is an additional benefit where components can be easily removed from an interconnected group by offsetting the adapter mounting rail without having to disassemble the entire three phase commoning link.



Optimum compatibility: Starters and busbar adapters

The xStart system has been extended by the new busbar adapter, which is compatible with the busbar system and the system accessories from Wöhner, the market leader in this field. Conformity to the standard ensures that busbar adapters for 60 mm busbar clearances fit all similar manufacturers

systems. An additional benefit is that the busbar adapter material used worldwide is a standard copper profile. Prefabricated connectors or the new tool-less plug connections are available for establishing connections between circuit-breakers and contactors. With large and uniform requirements, Moeller supplies the adapter fitted complete with switchgear for DOL and reversing starters.

Simply select tested motor starters to approval types I and II

The DOL starter (complete unit) consists of a PKZM0 motor-protective circuit-breaker and a DILM contactor.

Moeller provides a PC-based electronic selection program for motor starters in addition to the comprehensive selection page in the Moeller main catalogue. This program considers various

operating voltages, short-circuit ratings and coordination types, as well as fuseless and fused combinations.

This small program is available from Moeller free of charge on the Internet. Moeller has provided the practically-minded with a carton selection slider for a number of years.



www.moeller.net/select

Contactors DIL M7 – 150



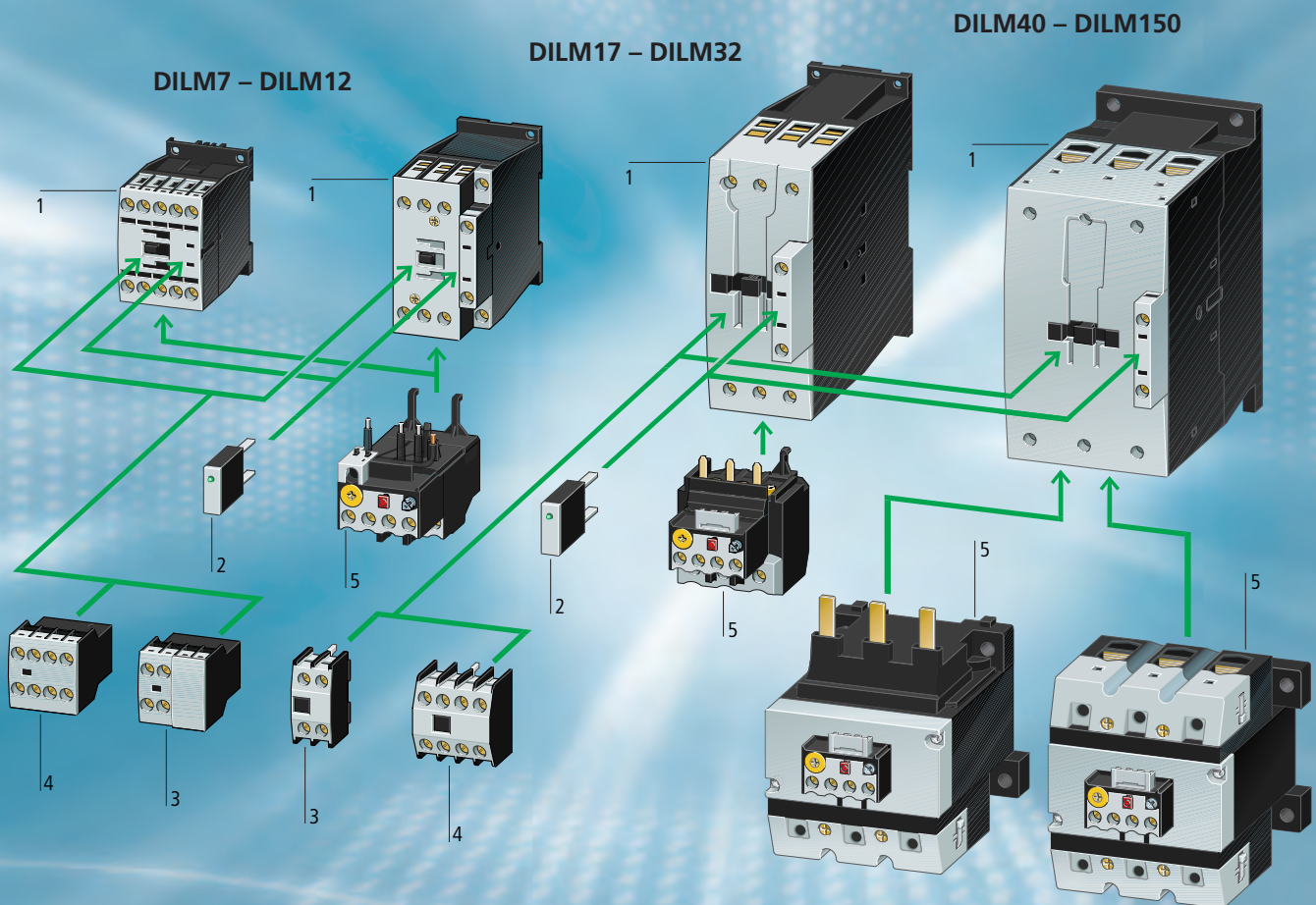

DILA contactor relays



1. Basic units
2. Suppressor ¹⁾
3. Auxiliary contact modules, 2-pole
4. Auxiliary contact modules, 4-pole
5. Overload relays

¹⁾ For AC operated contactors 50-60 Hz;
in DC operated contactors, the suppressor circuit is incorporated.
Note drop-out delay

DILM basic units

	AC-3 380 V 400 V I_e A	AC-3 380 V 400 V P kW	Open $I_{th} = I_e$ A	Contacts B = Break M = Make	Can be combined with auxiliary contact	AC operation Auxiliary contact			DC actuation
						Type Article no. 230 V 50 Hz 240 V 60 Hz	Type Article no. 24 V 50/60 Hz	Type Article no. 110 V 50 Hz, 120 V 60 Hz	Type Article no.
3-pole 	7	3	20	1 M	DILM32-XHI.. DILA-XHI(V)..	DILM7-10(...) 276550	DILM7-10(...) 276554	DILM7-10(...) 276547	DILM7-10(24VDC) 276565
	7	3		1 B	DILA-XHI(V)..	DILM7-01(...) 276585	DILM7-01(...) 276589	DILM7-01(...) 276582	DILM7-01(24VDC) 276600
	9	4	20	1 M	DILM32-XHI.. DILA-XHI(V)..	DILM9-10(...) 276690	DILM9-10(...) 276694	DILM9-10(...) 276687	DILM9-10(24VDC) 276705
	9	4		1 B	DILA-XHI(V)..	DILM9-01(...) 276725	DILM9-01(...) 276729	DILM9-01(...) 276722	DILM9-01(24VDC) 276740
	12	5.5	20	1 M	DILM32-XHI.. DILA-XHI(V)..	DILM12-10(...) 276830	DILM12-10(...) 276834	DILM12-10(...) 276827	DILM12-10(24VDC) 276845
	12	5.5		1 B	DILA-XHI(V)..	DILM12-01(...) 276865	DILM12-01(...) 276869	DILM12-01(...) 276862	DILM12-01(24VDC) 276880
	15.5	7.5	20	1 M	DILM32-XHI.. DILA-XHI(V)..	DILM15-10(...) 290057	DILM15-10(...) 290062	DILM15-10(...) 290055	DILM15-10(24VDC) 290073
	15.5	7.5		1 B	DILA-XHI(V)..	DILM15-01(...) 290093	DILM15-01(...) 290097	DILM15-01(...) 290090	DILM15-01(24VDC) 290108
4-pole	–	–	–	–	DILM32-XHI.. DILA-XHI(V)..	DILMP20(...) 276970	DILMP20(...) 276974	DILMP20(...) 276967	DILMP20(24VDC) 276985
3-pole 	18	7.5	35	1 M	DILM32-XHI.. DILA-XHI(V)..	DILM17-10(...) 277004	DILM17-10(...) 277008	DILM17-10(...) 277001	DILM17-10(RDC24) 277018
	18	7.5		1 B	DILA-XHI(V)..	DILM17-01(...) 277036	DILM17-01(...) 277040	DILM17-01(...) 277033	DILM17-01(RDC24) 277050
	25	11	40	1 M	DILM32-XHI.. DILA-XHI(V)..	DILM25-10(...) 277132	DILM25-10(...) 277136	DILM25-10(...) 277129	DILM25-10(RDC24) 277146
	25	11		1 B	DILA-XHI(V)..	DILM25-01(...) 277164	DILM25-01(...) 277168	DILM25-01(...) 277161	DILM25-01(RDC24) 277178
	32	15	40	1 M	DILM32-XHI.. DILA-XHI(V)..	DILM32-10(...) 277260	DILM32-10(...) 277264	DILM32-10(...) 277257	DILM32-10(RDC24) 277274
	32	15		1 B	DILA-XHI(V)..	DILM32-01(...) 277292	DILM32-01(...) 277296	DILM32-01(...) 277289	DILM32-01(RDC24) 277306
	40	18.5	50	–	DILM150-XHI(V).. DILM1000-XHI(V)..	DILM40(...) 277766	DILM40(...) 277770	DILM40(...) 277763	DILM40(RDC24) 277780
	50	22	60	–		DILM50(...) 277830	DILM50(...) 277834	DILM50(...) 277827	DILM50(RDC24) 277844
	65	30	72	–		DILM65(...) 277894	DILM65(...) 277898	DILM65(...) 277891	DILM65(RDC24) 277908
	80	37	110	–		DILM80(...) 239402	DILM80(...) 239406	DILM80(...) 239399	DILM80(RDC24) 239416
	95	45		–		DILM95(...) 239480	DILM95(...) 239484	DILM95(...) 239477	DILM95(RDC24) 239510
	115	55	160	–		DILM115(RAC240) 239548	DILM115(RAC24) 239545	DILM115(RAC120) 239547	DILM115(RDC24) 239555
	150	75		–		DILM150(RAC240) 239588	DILM150(RAC24) 239585	DILM150(RAC120) 239587	DILM150(RDC24) 239591





The listed auxiliary and main contacts up to 12 A are available with springloaded terminals.

The auxiliary contact modules listed for the DILA contactor relay can also be used for the DILM contactors up to 32 A.

Auxiliary contact members: DILA-XHI to EN 50005, DILM32-XHI to DIN 50012

The 2- and 4-pole DILM32-XHI... auxiliary contact modules can not be combined with DILM...-01 contactors.

Auxiliary contact modules²⁾









		$I_{in} = I_e$ open A	Contacts M = Make B = Break M_E = Early-make contacts B_L = Late-break contacts		Can be combined with basic units	Type	Article no.
	2-pole	10	1 M	1 B	DILM7-10...	DILM32-XHI11	277376
			–	2 B	DILM9-10... DILM12-10... DILM15-10... DILM17-10... DILM25-10... DILM32-10...	DILM32-XHI02	277375
	4-pole		2 M	2 B		DILM32-XHI22	277377
	2-pole		2 M	–	DILM7... DILM9... DILM12... DILM15... DILM17... DILM25... DILM32...	DILA-XHI20	276422
			1 M	1 B		DILA-XHI11	276421
	4-pole		–	2 B		DILA-XHI02	276420
			1 M_E	1 B_L		DILA-XHIV11	276423
			4 M	–		DILA-XHI40	276428
			3 M	1 B		DILA-XHI31	276427
			2 M	2 B		DILA-XHI22	276426
			1 M	3 B		DILA-XHI13	276425
			–	4 B		DILA-XHI04	276424
			1 M, 1 M_E	1 B, 1 B_L		DILA-XHIV22	276429
	2-pole	10	2 M	–	DILM40... DILM50... DILM65... DILM80... DILM95... DILM115... DILM150...	DILM150-XHI20	277945
			1 M	1 B		DILM150-XHI11	277946
	4-pole		–	2 B		DILM150-XHI02	277947
			4 M	–		DILM150-XHI40	277948
			3 M	1 B		DILM150-XHI31	277949
			2 M	2 B		DILM150-XHI22	277950
			1 M	3 B		DILM150-XHI13	277951
			–	4 B		DILM150-XHI04	277952
			1 M, 1 M_E	1 B, 1 B_L		DILM150-XHIV22	277953
			1 M	1 B		DILM1000-XHI11-SI	278425
–	2-pole		1 M	1 B		DILM150-XHIA11¹⁾	283463

The listed auxiliary and main contacts up to 12 A are available with springloaded terminals.
The auxiliary contact modules listed for the DILA contactor relay can also be used for the DILM contactors up to 32 A.
Auxiliary contact members: DILA-XHI to EN 50005, DILM32-XHI to DIN 50012
The 2- and 4-pole DILM32-XHI... auxiliary contact modules can not be combined with DILM...-01 contactors.

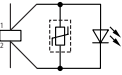
¹⁾ NEW: Also available as 4-pole version DILM150-XHIA22 with terminal markings 53/54, 61/62, 71/72 and 83/84
(Article no. 283464) in order to avoid duplication of terminal markings on combinations with auxiliary contact on the side.

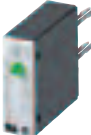
²⁾ The following applies for all auxiliary contact modules: $I_e=3$ A for AC-15 at 380 V, 400 V, 415 V

Accessories

	U_s V AC	For use with	Type	Article no.	Notes
Suppressor Varistor suppressor  	24 – 48	DILM7 – DILM15 DILMP20 DILA	DILM12-XSPV48	281208	For AC operated contactors, 50-60 Hz, DC operated contactors have an integrated suppressor Note drop-out delay
	48 – 130		DILM12-XSPV130	281209	
	130 – 240		DILM12-XSPV240	281210	
	240 – 500		DILM12-XSPV500	281211	
	24 – 48	DILM17 – DILM32	DILM32-XSPV48	281212	
	48 – 130		DILM32-XSPV130	281213	
	130 – 240		DILM32-XSPV240	281214	
	240 – 500		DILM32-XSPV500	281215	
	24 – 48	DILM40 – DILM95	DILM95-XSPV48	281216	
	48 – 130		DILM95-XSPV130	281217	
	130 – 240		DILM95-XSPV240	281218	
	240 – 500		DILM95-XSPV500	281219	
Varistor suppressors with built-in LED  	24 – 48	DILM7 – DILM15 DILMP20 DILA	DILM12-XSPVL48	281220	For AC operated contactors, 50-60 Hz, DC operated contactors have an integrated suppressor Note drop-out delay
	130 – 240		DILM12-XSPVL240	281221	
	24 – 48	DILM17 – DILM32	DILM32-XSPVL48	281222	
	130 – 240		DILM32-XSPVL240	281223	
	24 – 48	DILM40 – DILM95	DILM95-XSPVL48	281224	
	130 – 240		DILM95-XSPVL240	281225	
RC suppressor  	24 – 48	DILM7 – DILM15 DILMP20 DILA	DILM12-XSPR48	281199	For AC operated contactors, 50-60 Hz, DC operated contactors have an integrated suppressor Note drop-out delay
	130 – 240		DILM12-XSPR240	281200	
	240 – 500		DILM12-XSPR500	281201	
	24 – 48	DILM17 – DILM32	DILM32-XSPR48	281202	
	110 – 240		DILM32-XSPR240	281203	
	240 – 500		DILM32-XSPR500	281204	
	24 – 48	DILM40 – DILM95	DILM95-XSPR48	281205	
	110 – 240		DILM95-XSPR240	281206	
	240 – 500		DILM95-XSPR500	281207	
	24 – 48		DILM7-DILM15 DILMP20 DILA	DILM12-XSPI48	
48 – 130	DILM12-XSPI130	285252			
130 – 250	DILM12-XSPI250	285253			
Voltage indicator  	24 – 48	DILM17-DILM32	DILM32-XSPI48	285254	
	48 – 130		DILM32-XSPI130	285255	
	130 – 250		DILM32-XSPI250	285256	
	24 – 48	DILM40-DILM150	DILM150-XSPI48	285257	
	48 – 130		DILM150-XSPI130	285258	
	130 – 250		DILM150-XSPI250	285259	
	24 – 48		DILM7 – DILM65 DILA	DILM32-XVB	281227
48 – 130	DILM150-XVB	281226			
Connector For the mechanical connection of contactors to groups of components 	24 – 48	DILM7 – DILM15 DILMP20 DILA	DILM12-XMV	281196	For two contactors with AC or DC operation, distance between contactors 0 mm, mechanical lifespan 2.5×10^6 switching operations, additional auxiliary contact modules can be fitted
	48 – 130		DILM32-XMV	281197	
	130 – 250		DILM65-XMV	281198	
	240 – 500		DILM150-XMV	240081	
	24 – 48				
Mechanical interlock 	24 – 48	DILM7 – DILM15 DILMP20 DILA	DILM12-XMV	281196	For two contactors with AC or DC operation, distance between contactors 0 mm, mechanical lifespan 2.5×10^6 switching operations, additional auxiliary contact modules can be fitted
	48 – 130		DILM32-XMV	281197	
	130 – 250		DILM65-XMV	281198	
	240 – 500		DILM150-XMV	240081	
	24 – 48				

Technical data

				DILM7	DILM9	DILM12	DILM15
General							
Lifespan, mechanical							
AC operated		Operations	$\times 10^6$	10	10	10	10
DC operated		Operations	$\times 10^6$	10	10	10	10
Ambient temperature	open		°C	-25/60	-25/60	-25/60	-25/60
Mechanical shock resistance (IEC/EN 60068-2-27)							
Half-sinusoidal shock	Main contacts	Make contact	g	10	10	10	10
	Auxiliary contacts	Make contact	g	7	7	7	7
		Break contact	g	5	5	5	5
Weight	AC operated		kg	0.23	0.23	0.23	0.23
	DC operated		kg	0.28	0.28	0.28	0.28
Terminal capacity, main contacts							
Solid			mm ²			1 × (0.75 – 4) 2 × (0.75 – 2.5)	
Flexible with ferrule			mm ²			1 × (0.75 – 4) 2 × (0.75 – 2.5)	
Stranded			mm ²	–	–	–	–
Solid or stranded			AWG	18 – 14	18 – 14	18 – 14	18 – 14
Flat conductor		Number of layers × width × thickness	mm	–	–	–	–
Terminal capacity, auxiliary contacts							
Solid			mm ²			1 × (0.75 – 4) 2 × (0.75 – 2.5)	
Flexible with ferrule			mm ²			1 × (0.75 – 2.5) 2 × (0.75 – 2.5)	
Solid or stranded			AWG	18 – 14	18 – 14	18 – 14	18 – 14
Main contacts							
Rated insulation voltage		U_i	V AC	690	690	690	690
Rated operational voltage		U_e	V AC	690	690	690	690
Making capacity (cos φ to IEC/EN 60947) to 690 V			A	108	108	144	155
Breaking capacity	220/230 V		A	70	90	120	124
	380/400 V		A	70	90	120	124
	500 V		A	50	70	100	100
	660/690 V		A	40	50	70	70
	1000 V		A	–	–	–	–
Component lifespan	AC-3	Operations	$\times 10^6$	1.3	1.3	1.3	0.75
	AC-4	Operations	$\times 10^6$	0.2	0.2	0.2	0.2

Technical data

DILM17	DILM25	DILM32	DILM40	DILM50	DILM65	DILM80	DILM95	DILM115	DILM150
10	10	10	10	10	10	10	10	10	10
10	10	10	10	10	10	10	10	10	10
-25/60	-25/60	-25/60	-25/60	-25/60	-25/60	-25/60	-25/60	-25/60	-25/60
10	10	10	10	10	10	10	10	10	10
7	7	7	7	7	7	7	7	7	7
5	5	5	5	5	5	5	5	5	5
0.4	0.4	0.4	0.9	0.9	0.9	2	2	2	2
0.4	0.4	0.4	0.9	0.9	0.9	2.1	2.1	2.1	2.1
	1 × (0.75 – 16) 2 × (0.75 – 10)			1 × (2.5 – 16) 2 × (2.5 – 16)				–	
	1 × (0.75 – 16) 2 × (0.75 – 10)			1 × (2.5 – 35) 2 × (2.5 – 25)		1 × (4 – 70) 2 × (4 – 50)		1 × (10 – 95) 2 × (10 – 70)	
	1 × 16			1 × (16 – 50) 2 × (16 – 35)		1 × (16 – 95) 2 × (16 – 70)		1 × (16 – 120) 2 × (16 – 95)	
14 – 6	14 – 6	14 – 6	12 – 2	12 – 2	12 – 2	10 – 4/0	10 – 4/0	8 – 250 MCM	8 – 250 MCM
–	–	–		2 × (6 × 9 × 0.8)				2 × (6 × 16 × 0.8)	
				1 × (0.75 – 4) 2 × (0.75 – 2.5)				1 × (0.75 – 4) 2 × (0.75 – 4)	
				1 × (0.75 – 2.5) 2 × (0.75 – 2.5)				1 × (0.75 – 2.5) 2 × (0.75 – 2.5)	
18 – 14	18 – 14	18 – 14	18 – 14	18 – 14	18 – 14	18 – 14	18 – 14	18 – 14	18 – 14
690	690	690	690	690	690	1000	1000	1000	1000
690	690	690	690	690	690	1000	1000	1000	1000
238	350	448	560	700	910	1120	1330	1610	2100
170	250	320	400	500	650	800	950	1150	1500
170	250	320	400	500	650	800	950	1150	1500
170	250	320	400	500	650	800	950	1150	1500
120	150	180	250	320	370	650	800	1100	1320
–	–	–	–	–	–	320	370	450	550
1.3	1.3	1.3	1.3	1.3	1.3	0.4	0.4	0.4	0.4
0.2	0.2	0.2	0.2	0.2	0.2	0.1	0.1	0.1	0.1

Technical data

					DILM7	DILM9	DILM12	DILM15
AC								
AC-1 actuation								
Conventional free air thermal	Open	at 40 °C	A	22	22	22	22	
Current 3-pole	50 – 60 Hz	at 60 °C	A	20	20	20	20	
AC actuation								
Rated operational current, AC-3 open, 50 – 60 Hz, 3-pole	220/230 V	I_e	A	7	9	12	15.5	
	380/400 V	I_e	A	7	9	12	15.5	
	500 V	I_e	A	5	7	10	12.5	
	660/690 V	I_e	A	4	5	7	8.5	
Motor rating	220/230 V	P	kW	2.2	2.5	3.5	4	
	380/400 V	P	kW	3	4	5.5	7.5	
	500 V	P	kW	3.5	4.5	7	7.5	
	660/690 V	P	kW	3.5	4.5	6.5	7	
Magnet systems								
Pick-up and drop-out values								
AC operated		Pick-up	$\times U_c$	0.8 – 1.1	0.8 – 1.1	0.8 – 1.1	0.8 – 1.1	
DC operated		Pick-up	$\times U_c$	0.8 – 1.1	0.8 – 1.1	0.8 – 1.1	0.8 – 1.1	
Coil consumption from cold and $1.0 \times U_c$								
AC operated	50 Hz coil 60 Hz coil	Pick-up	VA	24 29	24 29	24 29	24 29	
			W	19 23	19 23	19 23	19 23	
		Sealing	VA	4.0 4.4	4.0 4.4	4.0 4.4	4.0 4.4	
			W	1.2 1.3	1.2 1.3	1.2 1.3	1.2 1.3	
		DC operated	Pick-up	W	3	3	4.5	4.5
			Sealing	W	3	3	4.5	4.5

Dimensions

DILM7 – DILM15, DILA with auxiliary contact module

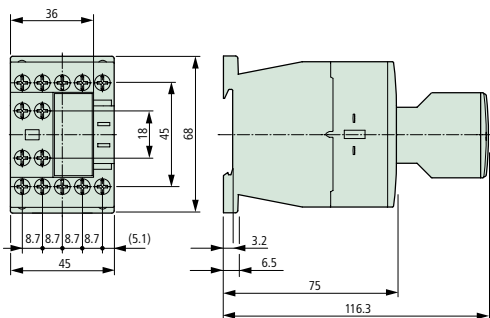

DILM17 – DILM32 basic unit with auxiliary contact module

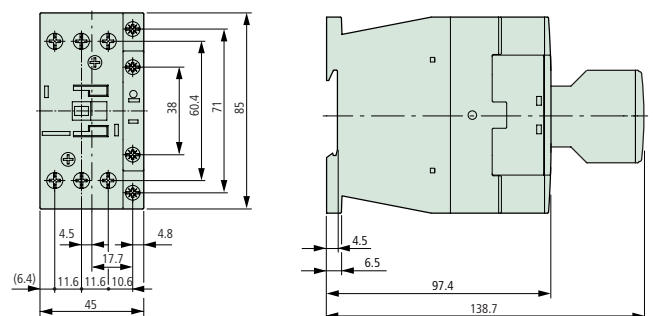

Technical data

DILM17	DILM25	DILM32	DILM40	DILM50	DILM65	DILM80	DILM95	DILM115	DILM150
40	45	45	60	70	85	130	130	190	190
35	36	36	50	60	72	110	110	160	160
18	25	32	40	50	65	80	95	115	150
18	25	32	40	50	65	80	95	115	150
18	25	32	40	50	65	80	95	115	150
12	15	18	25	32	37	65	80	110	132
5	7.5	10	12.5	15.5	20	25	30	37	48
7.5	11	15	18.5	22	30	37	45	55	75
12	17.5	23	28	36	47	58	70	85	110
11	14	17	23	30	35	63	75	105	125
0.8 – 1.1	0.8 – 1.1	0.8 – 1.1	0.8 – 1.1	0.8 – 1.1	0.8 – 1.1	0.8 – 1.1	0.8 – 1.1	0.8 – 1.1	0.8 – 1.1
0.7 – 1.2	0.7 – 1.2	0.7 – 1.2	0.7 – 1.2	0.7 – 1.2	0.7 – 1.2	0.7 – 1.2	0.7 – 1.2	0.7 – 1.2	0.7 – 1.2
50 62	50 62	50 62	150 185	150 185	150 185	310 375	310 375	130 130	130 130
40 50	40 50	40 50	95 120	95 120	95 120	165 190	165 190	130 130	130 130
8.0 9.1	8.0 9.1	8.0 9.1	16.0 19.0	16.0 19.0	16.0 19.0	26.0 31.0	26.0 31.0	3.5 3.5	3.5 3.5
2.4 2.7	2.4 2.7	2.4 2.7	4.0 4.6	4.0 4.6	4.0 4.6	5.5 6.8	5.5 6.8	2.0 2.0	2.0 2.0
12 at 24 V	12 at 24 V	12 at 24 V	24 at 24 V	24 at 24 V	24 at 24 V	90 at 24 V	90 at 24 V	130 at 24 V	130 at 24 V
0.5 at 24 V	0.5 at 24 V	0.5 at 24 V	0.5 at 24 V	0.5 at 24 V	0.5 at 24 V	2 at 24 V	2 at 24 V	2 at 24 V	2 at 24 V

Dimensions

DILM40 – DILM65 basic unit with auxiliary contact module

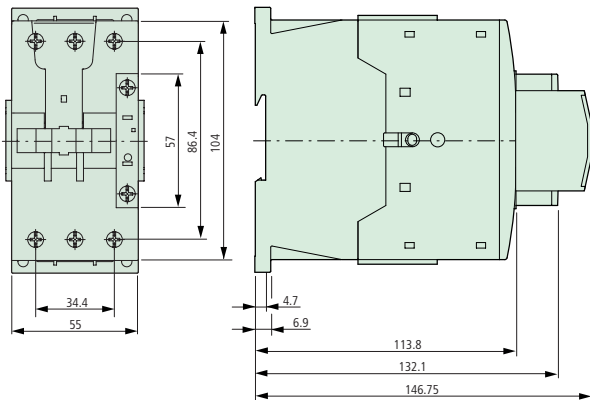

DILM80 – DILM150 basic unit with auxiliary contact module

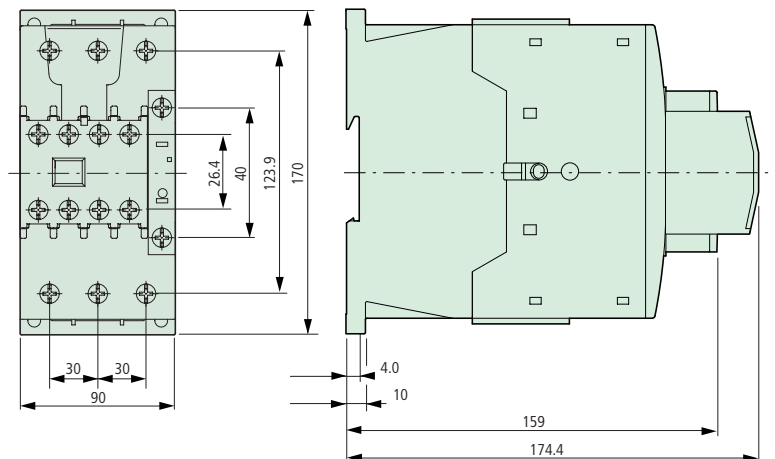



DILA contactor relays

	Contacts		AC-15 380 V 400 V 415 V	I_e A	I_{th} A	Can be combined with auxiliary contact	AC operation			DC operation
	M = Make B = Break						Type	Type	Type	
							Article no. 230 V 50 Hz 240 V 60 Hz	Article no. 24 V 50/60 Hz	Article no. 110 V 50 Hz 120 V 60 Hz	24 V DC
 Basic units with interlocked opposing contacts	4 M	–	4	10	DILA-XHI(V)...	DILA-40(...) 276329	DILA-40(...) 276333	DILA-40(...) 276326	DILA-40(...) 276344	
	3 M	1 B	4	10	DILA-XHI(V)...	DILA-31(...) 276364	DILA-31(...) 276368	DILA-31(...) 276361	DILA-31(...) 276379	
	2 M	2 B	4	10	DILA-XHI(V)...	DILA-22(...) 276399	DILA-22(...) 276403	DILA-22(...) 276396	DILA-22(...) 276414	

The listed auxiliary and main contacts up to 12 A are available with springloaded terminals.
 The auxiliary contact modules listed for the DILA contactor relay can also be used for the DILM contactors up to 32 A.
 Auxiliary contact members: DILA-XHI to EN 50005, DILM32-XHI to DIN 50012
 The DILA-22 contactor relay can not be combined with the 4-pole auxiliary contact module.

DILA auxiliary contact modules

	Contacts		Rated operating current AC-15 380 V 400 V 415 V	Conventional current, open at 60 °C	Can be combined with basic unit	Type Article no.
	M = Make contact, B = Break contact M_E = Early-make contacts B_L = Late-break contacts					
 2-pole	–	2 B	3	10	DILA... DILM7... DILM9... DILM12... DILM15... DILM17... DILM25... DILM32...	DILA-XHI02 276420
	1 M	1 B				DILA-XHI11 276421
	2 M	–				DILA-XHI20 276422
	1 M_E	1 B_L				DILA-XHIV11 276423
 4-pole	–	4 B	3	10	DILA-40... DILA-31... DILM7... DILM9... DILM12... DILM15... DILM17... DILM25... DILM32...	DILA-XHI04 276424
	1 M	3 B				DILA-XHI13 276425
	2 M	2 B				DILA-XHI22 276426
	3 M	1 B				DILA-XHI31 276427
	4 M	–				DILA-XHI40 276428
	1 M, 1 M_E	1 B, 1 B_L				DILA-XHIV22 276429

→ Dimensions Page 18

Technical data









				DILA	DILA-XHI...
General					
Lifespan, mechanical					
AC operated	Operations	$\times 10^6$	20	20	
DC operated	Operations	$\times 10^6$	20	20	
Ambient temperature					
open		°C	-25/60	-25/60	
Weight					
AC operated		kg	0.19		
DC operated		kg	0.19		
Terminal capacity					
Screw terminals					
Solid		mm ²	1 × (0.75 – 4)		
			2 × (0.75 – 2.5)		
Flexible with ferrule		mm ²	1 × (0.75 – 2.5)		
			2 × (0.75 – 2.5)		
Solid or stranded		AWG	18 – 14		
Contacts					
Rated insulation voltage	U_i	V AC	690	690	
Rated operational voltage	U_e	V AC	690	500	
Rated operational current					
AC-15	220/240 V	I_e	A	6	6
	380/415 V	I_e	A	4	3
	500 V	I_e	A	1.5	–
DC-13 ¹⁾	DC-13 L/R ≤ 15 ms				
	Contacts in series:				
	1	24 V	A	–	–
Fault frequency at $U_e = 24$ V DC, $U_{min} = 17$ V, $I_{min} = 5.4$ mA		Fault rate	H _f	$< 10^{-8}$, < 1 failure to 100 million switching operations	
Magnet systems					
Pick-up and drop-out values					
AC operated					
50 Hz single-voltage coil and 50/60 Hz dual-voltage coil	Pick-up	$\times U_s$	0.8 – 1.1	–	
	Pick-up	$\times U_s$	0.8 – 1.1	–	
DC operated ²⁾					
Pick-up voltage	Pick-up	$\times U_s$	0.8 – 1.1	–	
Without auxiliary contact module (40 °C)	Pick-up	$\times U_c$	0.7 – 1.3	–	
Power consumption					
50 Hz single-voltage coil and 50/60 Hz dual-voltage coil	Pick-up	VA	24	–	
	Pick-up	W	19	–	
50 Hz single-voltage coil and 50/60 Hz dual-voltage coil	Sealing	VA	4	–	
	Sealing	W	1.2	–	
DC operated	Pick-up = Sealing	W	3	–	

Notes

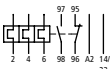
¹⁾ Making and breaking currents to DC-13 time constant as stated

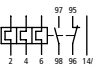
²⁾ Smoothed DC or three-phase bridge rectifier

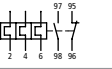
ZB overload relays

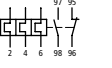
	Overload release setting range I_r A 	For use with	Short-circuit protection Coordination type gG/gL A 		Type	Article no.		
			"1"	"2"				
ZB12 overload relays Single-phasing sensitivity to IEC/EN 60947, VDE 0660 Part 102 Direct fitting  	0.1 – 0.16	DILM7, DILM9, DILM12, DIULM7, DIULM9, DIULM12, SDAINLM12, SDAINLM16, SDAINLM22	25	0.5	ZB12-0,16	278431	Overload release: tripping class 10 A Short-circuit protection: when fitting directly, note maximum admissible fuse for the contactor. Suitable for the protection of EEx e-motors. EU prototype test certificate available on request.	
	0.16 – 0.24			1	ZB12-0,24	278432		
	0.24 – 0.4			2	ZB12-0,4	278433		
	0.4 – 0.6			4	ZB12-0,6	278434		
	0.6 – 1			4	ZB12-1,0	278435		
	1 – 1.6			6	ZB12-1,6	278436		
	1.6 – 2.4			10	ZB12-2,4	278437		
	2.4 – 4			16	ZB12-4	278438		
	4 – 6			20	ZB12-6	278439		
	6 – 10			50	25	ZB12-10		278440
	9 – 12				ZB12-12	278441		
	12 – 16				ZB12-16	290168		
	ZB32 overload relays Single-phasing sensitivity to IEC/EN 60947, VDE 0660 Part 102 Direct fitting  			0.1 – 0.16	DILM17, DILM25, DILM32, DIULM17, DIULM25, DIULM32, SDAINLM30, SDAINLM45, SDAINLM55	25		0.5
0.16 – 0.24		1	ZB32-0,24	278443				
0.24 – 0.4		2	ZB32-0,4	278444				
0.4 – 0.6		4	ZB32-0,6	278445				
0.6 – 1		4	ZB32-1,0	278446				
1 – 1.6		6	ZB32-1,6	278447				
1.6 – 2.4		10	ZB32-2,4	278448				
2.4 – 4		16	ZB32-4	278449				
4 – 6		20	ZB32-6	278450				
6 – 10		50	25	ZB32-10			278451	
10 – 16			35	ZB32-16			278452	
16 – 24			100	ZB32-24			278453	
24 – 32			125	ZB32-32			278454	
ZB65 overload relays Single-phasing sensitivity to IEC/EN 60947, VDE 0660 Part 102 Direct fitting  	6 – 10	DILM40, DILM50, DILM65, DIULM40, DIULM50, DIULM65, SDAINLM70, SDAINLM90, SDAINLM115	50	25	ZB65-10	278455	Overload release: tripping class 10 A Short-circuit protection: when fitting directly, note maximum admissible fuse for the contactor. Suitable for the protection of EEx e-motors. EU prototype test certificate available on request.	
	10 – 16			35	ZB65-16	278456		
	16 – 24			50	ZB65-24	278457		
	24 – 40			63	ZB65-40	278458		
	40 – 57			80	ZB65-57	278459		
	50 – 65			100	ZB65-65	278460		
ZB150 overload relays Single-phasing sensitivity to IEC/EN 60947, VDE 0660 Part 102 Direct fitting  	25-35	DILM80, DILM95, DILM115, DILM150, DIULM80, DIULM95, DIULM115, DIULM150, SDAINLM140, SDAINLM165, SDAINLM200, SDAINLM260	125	100	ZB150-35	278461	Overload release: tripping class 10 A Short-circuit protection: when fitting directly, note maximum admissible fuse for the contactor. Suitable for the protection of EEx e-motors. EU prototype test certificate available on request.	
	35-50			125	ZB150-50	278462		
	50-70			160	ZB150-70	278463		
	70-100			200	ZB150-100	278464		
	95-125			250	ZB150-125	278465		
	120-142			250	ZB150-150	278466		

Overload relay technical data

				ZB12, ZB32	ZB65	ZB150
General						
Standards and regulations				IEC/EN 60947, VDE 0660, UL, CSA		
Ambient temperature						
open ¹⁾	°C		-25/50	-25/50	-25/50	
enclosed ¹⁾	°C		-25/40	-25/40	-25/40	
Main contacts						
Rated operational voltage		U_e	V AC	690	690	1000
Terminal capacity						
Solid		mm ²	$2 \times (1 - 6)$	$2 \times (1 - 16)$	16	
Flexible without ferrule		mm ²	–	–	70	
Flexible with ferrule		mm ²	$2 \times (1 - 4)$ $2 \times (1 - 6)^{2)}$	1×25 $2 \times (1 - 10)^{3)}$	70	
Solid or stranded		AWG	14 – 8	14 – 2	2/0	
Auxiliary circuits and control circuits						
Conventional free air thermal current		I_{th}	A	6	6	6
Rated operational current						
AC-15						
Make contact	240 V	I_e	A	1.5	1.5	1.5
	415 V	I_e	A	0.5	0.5	0.5
	500 V	I_e	A	0.5	0.5	0.5
Break contact	240 V	I_e	A	1.5	1.5	1.5
	415 V	I_e	A	0.9	0.9	0.9
	500 V	I_e	A	0.8	0.8	0.8
DC-13 L/R $\leq 15 \text{ ms}^4)$						
	24 V	I_e	A	0.9	0.9	0.9
	60 V	I_e	A	0.75	0.75	0.75
	110 V	I_e	A	0.4	0.4	0.4
	220 V	I_e	A	0.2	0.2	0.2

Notes

¹⁾ Ambient temperature: operating range to IEC/EN 60947, PTB: -5 °C to +50 °C

²⁾ 6 mm² flexible with ferrule to DIN 46228

³⁾ Terminal capacity of main contacts solid and flexible with ferrule: when using 2 conductor of equal cross-section

⁴⁾ Rated operational current: making and breaking currents to DC-13, time constant as stated

Dimensions

ZB12/ZB32

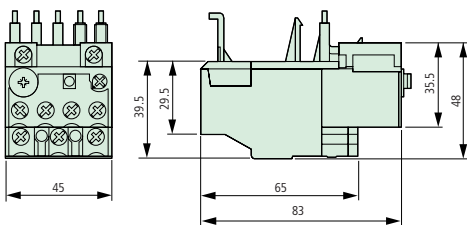

ZB150

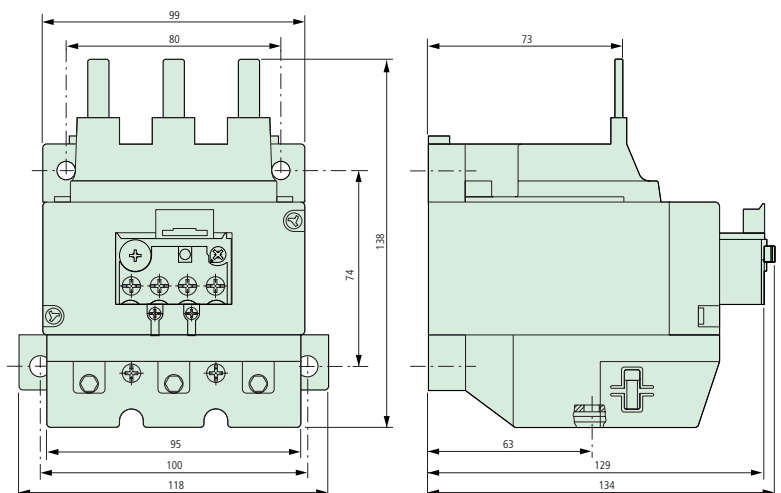

ZB65

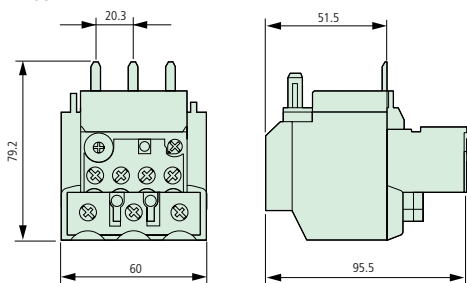



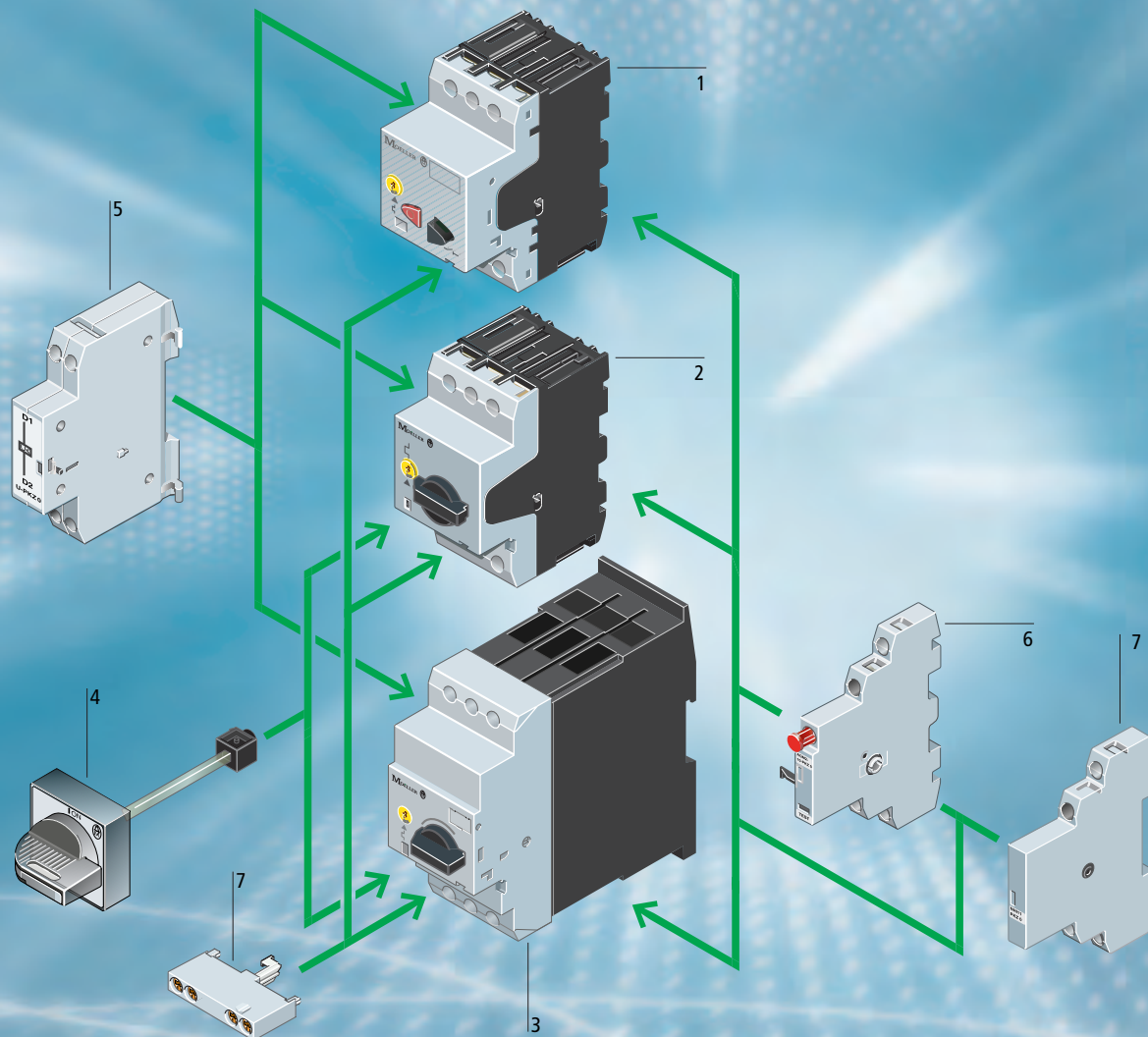

PKZ

motor-protective circuit-breaker



1. PKZM01 motor-protective circuit-breaker
2. PKZM0 motor-protective circuit-breaker
3. PKZM4 motor-protective circuit-breaker
4. Door coupling rotary handle IP65
5. Voltage release
6. Trip-indicating auxiliary contact
7. Auxiliary contacts

PKZM0, PKZM4 motor-protective circuit-breakers

	Max. motor rating AC-3 380 V 400 V 415 V <i>P</i> kW	Rated uninterrupted current I_u A	Setting range		Screw terminals Type Article no.
			Overload releases I_r A 	Short-circuit release I_m A 	
Motor-protective circuit-breakers, coordination type "1" and "2" 	–	0.16	0.1 – 0.16	2.2	PKZM0-0,16 072730
	0.06	0.25	0.16 – 0.25	3.5	PKZM0-0,25 072731
	0.09	0.4	0.25 – 0.4	5.6	PKZM0-0,4 072732
	0.12	0.63	0.4 – 0.63	8.8	PKZM0-0,63 072733
	0.25	1	0.63 – 1	14	PKZM0-1 072734
	0.55	1.6	1 – 1.6	22	PKZM0-1,6 072735
	0.75	2.5	1.6 – 2.5	35	PKZM0-2,5 072736
	1.5	4	2.5 – 4	56	PKZM0-4 072737
	2.2	6.3	4 – 6.3	88	PKZM0-6,3 072738
	4	10	6.3 – 10	140	PKZM0-10 072739
	5.5	12	9 – 12	168	PKZM0-12 278486
	7.5	16	10 – 16	224	PKZM0-16 046938
	9	20	16 – 20	280	PKZM0-20 046988
	12.5	25	20 – 25	350	PKZM0-25 046989
15	32	25 – 32	448	PKZM0-32 278489	
Motor-protective circuit-breaker, coordination type "1" and "2" 	7.5	16	10 – 16	224	PKZM4-16 222350
	12.5	25	16 – 25	350	PKZM4-25 222352
	15	32	25 – 32	448	PKZM4-32 222353
	20	40	32 – 40	560	PKZM4-40 222354
	25	50	40 – 50	700	PKZM4-50 222355
	30	58	50 – 58	812	PKZM4-58 222394
	34	65	55 – 65	882	PKZM4-63 222413

Note



Three-phase motors (approximate values for squirrel-cage rotors)

PKZM01 motor-protective circuit-breaker







	Max. motor rating AC-3 380 V 400 V 415 V <i>P</i> kW	Rated uninterrupted current <i>I_u</i> A	Setting range		Screw terminals Type Article no.
			Overload releases <i>I_r</i> A	Short-circuit releases <i>I_{im}</i> A	
Motor-protective circuit-breakers, coordination type "1" and "2" 	–	0.16	0.1 – 0.16	2.2	PKZM01-0,16 278475
	0.06	0.25	0.16 – 0.25	3.5	PKZM01-0,25 278476
	0.09	0.4	0.25 – 0.4	5.6	PKZM01-0,4 278477
	0.12	0.63	0.4 – 0.63	8.8	PKZM01-0,63 278478
	0.25	1	0.63 – 1	14	PKZM01-1 278479
	0.55	1.6	1 – 1.6	22	PKZM01-1,6 278480
	0.75	2.5	1.6 – 2.5	35	PKZM01-2,5 278481
	1.5	4	2.5 – 4	56	PKZM01-4 278482
	2.2	6.3	4 – 6.3	88	PKZM01-6,3 278483
	4	10	6.3 – 10	140	PKZM01-10 278484
	5.5	12	8 – 12	168	PKZM01-12 278485
	7.5	16	10 – 16	224	PKZM01-16 283390

Note Three-phase motors (approximate values for squirrel-cage rotors)

Insulated enclosures

	Protection type	For use with	Type Article no.
Insulated enclosures for surface mounting 	–	PKZM01+NHI-E or VHI-PKZ01+U or A or NHI+L (2 off)	CI-PKZ01 281403
	With actuating diaphragm	PKZM01+NHI-E or VHI-PKZ01+U or A or NHI+L (2 off)	CI-PKZ01-G 281404
	Lockable in the Off position	PKZM01+NHI-E+U or A (undervoltage or shunt release)+L (2 off)	CI-PKZ01-SVB 281405
	Lockable in the Off position, in conjunction with VHI-PKZ01	PKZM01+NHI-E or VHI-PKZ01+U or A (undervoltage or shunt release)+L (2 off)	CI-PKZ01-SVB-V 281944
	With stay-put Emergency-Stop mushroom button	PKZM01+NHI-E or VHI-PKZ01+U or A (undervoltage or shunt release)+L (2 off)	CI-PKZ01-PVT 281406
	With key-release Emergency-Stop mushroom button	PKZM01+NHI-E or VHI-PKZ01+U or A (undervoltage or shunt release)+L (2 off)	CI-PKZ01-PVS 281407
Insulated enclosures for flush mounting 	–	PKZM01+NHI-E or VHI-PKZ01+U or A or NHI+L (2 off)	E-PKZ01 281633
	With actuating diaphragm	PKZM01+NHI-E or VHI-PKZ01+U or A or NHI+L (2 off)	E-PKZ01-G 281634
	Lockable in the Off position	PKZM01+NHI-E or VHI-PKZ01+U or A (undervoltage or shunt release)+L (2 off)	E-PKZ01-SVB 281635
	Lockable in the Off position, in conjunction with VHI-PKZ01	PKZM01+NHI-E or VHI-PKZ01+U or A (undervoltage or shunt release)+L (2 off)	E-PKZ01-SVB-V 281943
	With stay-put Emergency-Stop mushroom button	PKZM01+NHI-E or VHI-PKZ01+U or A (undervoltage or shunt release)+L (2 off)	E-PKZ01-PVT 281636
	With key-release Emergency-Stop mushroom button	PKZM01+NHI-E or VHI-PKZ01+U or A (undervoltage or shunt release)+L (2 off)	E-PKZ01-PVS 281637

Accessories

	Contacts M = Make B = Break		Type of current AC/DC	For use with	Type Article no. when ordered separately
Trip-indicating auxiliary contact 	2 × 1 M	–	–	PKZM0 PKZM4 PKZM01	AGM2-10-PKZ0 072898
	–	2 × 1 B	–		AGM2-01-PKZ0 072899
Early-make auxiliary contacts 	2 M	–	–	PKZM0 PKZM01	VHI20-PKZ0 203595
	–	2 M	–		VHI20-PKZ01 278495
Shunt release 	–	–	AC operation	PKZM0 PKZM4 PKZM01	A-PKZ0(230V50HZ) 073187
	–	–	DC operation		A-PKZ0(24VDC) 073200
Undervoltage release 	–	–	AC operation	PKZM0 PKZM4 PKZM01	U-PKZ0(230V50HZ) 4073135
Standard auxiliary contact 	1 M	1 B	–	PKZM0 PKZM4 PKZM01	NHI11-PKZ0 072896
	1 M	2 B	–		NHI12-PKZ0 072895
	2 M	1 B	–		NHI21-PKZ0 072894
Standard auxiliary contact 	1 M	1 B	–		NHI-E-11-PKZ0 082882
	1 M	–	–		NHI-E-10-PKZ0 082884

Technical data basic units

			PKZM01...	PKZM0-...	PKZM4
General					
Ambient temperature					
open	°C		-25/55	-25/55	-25/55
Terminal capacity					
Solid	mm ²		1 × (1 – 6) 2 × (1 – 6)	1 × (1 – 6) 2 × (1 – 6)	1 × (1 – 50) 2 × (1 – 35)
Flexible with ferrule	mm ²		1 × (1 – 6) 2 × (1 – 6)	1 × (1 – 6) 2 × (1 – 6)	1 × (1 – 35) 2 × (1 – 35)
Solid or stranded	AWG		18 – 10	18 – 10	14 – 2
Tightening torque, terminal screws					
Main contacts	Nm		1.7	1.7	3
Auxiliary contacts	Nm		1	1	1
Main contacts					
Rated operational voltage	U_e	V AC	690	690	690
Rated uninterrupted current = rated operational current	$I_u = I_e$	A	16 or setting current of overcurrent release	32 or setting current of overcurrent release	65 open 63 enclosed or setting current of overcurrent release
Lifespan, mechanical	Operations	× 10 ⁶	0.05	0.1	0.03
Lifespan, electric (AC-3 at 400 V)	Operations	× 10 ⁶	0.05	0.1	0.03
Maximum operating frequency		S/h	40	40	40
Releases					
Temperature compensation					
to IEC/EN 60947, VDE 0660	°C		-5/40	-5/40	-5/40
Operating range	°C		-25/55	-25/55	-25/55
Setting range, overload release	× I_u		0.6 – 1	0.6 – 1	0.6 – 1
Short-circuit release fixed	× I_u		14	14	14
Phase-failure sensitivity			IEC/EN 60947-4-1, VDE 0660 Part 102	IEC/EN 60947-4-1, VDE 0660 Part 102	IEC/EN 60947-4-1, VDE 0660 Part 102

Technical data auxiliary contacts

			NHI...PKZ0	NHI-E-...PKZ0	VHI...PKZ0	AGM
Terminal capacity						
Solid or flexible with ferrule	mm ²		0.75 – 2.5	0.75 – 1.5	0.75 – 1.5	0.75 – 2.5
Solid or stranded	AWG		18 – 14	18 – 16	18 – 16	18 – 14

PKZM, dimensions

Motor-protective circuit-breakers

PKZM0-...(+NHI-E-...-PKZ0)

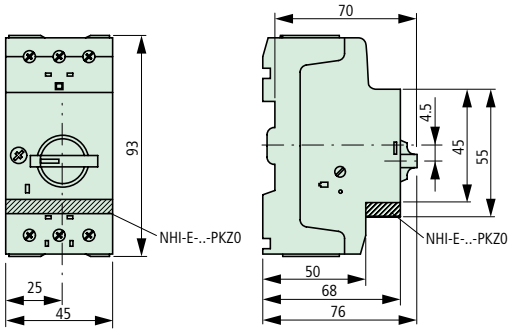

Motor-protective circuit-breaker with early-make auxiliary contact

PKZM0-...+VHI-...-PKZ0

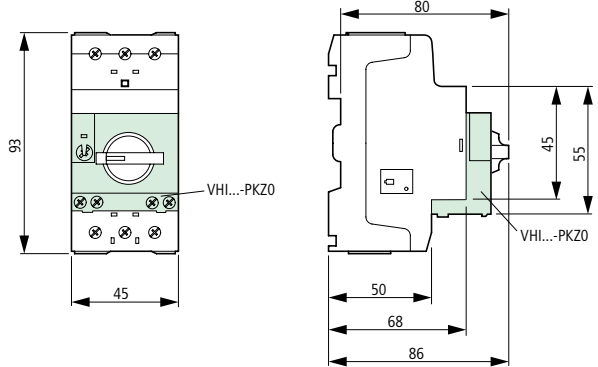

Standard auxiliary contact

NHI...-PKZ0

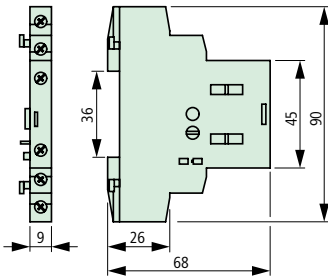

Trip-indicating auxiliary contact

AGM2-...-PKZ0

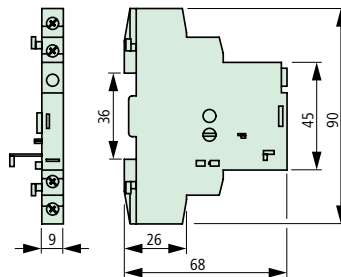

Voltage release

U/A-PKZ0

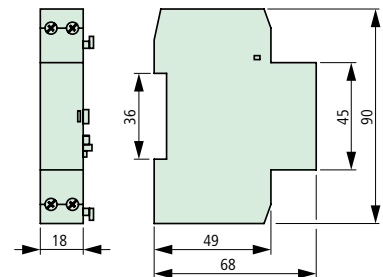

Motor-protective circuit-breakers

PKZM01

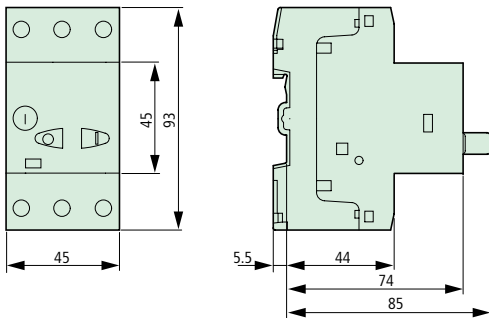

Switching capacity with coordination type "1" and "2"

PKZM0

PKZM01

I_u A	400 V				A ¹⁾	400 V			
	I_q kA	I_{cu} kA	I_{cs} kA	□		I_q kA	I_{cu} kA	I_{cs} kA	□
0.16 – 1	150	150	150	N	0	50	50	50	50
1.6	150	150	150	N	50	50	50	50	50
2.5	150	150	150	N	50	50	50	50	50
4	150	150	150	N	50	50	50	50	50
6.3	150	150	150	N	50	50	50	50	50
10	150	150	150	N	50	50	50	50	50
12	50	50	10	50	50	50	10	50	50
16	50	50	10	50	–	–	–	–	–
20	50	50	10	50	–	–	–	–	–
25	50	50	10	50	–	–	–	–	–
32	50	50	10	50	–	–	–	–	–

Rated uninterrupted current I_u
 Rated conditional short-circuit current I_q IEC/EN 60947-4-1
 Rated ultimate short-circuit breaking capacity I_{cu}
 Rated breaking capacity I_{cs} } IEC/EN 60947-2

1) Required back-up fuse, if the short-circuit current exceeds the rated conditional short-circuit current of the devices ($I_{cc} > I_q$).

2) Fuse (A gG/gL) to raise the switching capacity of the motor-protective circuit-breaker to 100 kA

N Not required

□ No upstream protective device necessary, since inherently protected range ((100/150 kA)

Direct-on-line starter, 400/415 V

Motor starter Coordination type "1"

Actuating voltage
230 V 50 Hz
240 V 60 Hz

Actuating voltage
24 V DC

Motor data

Setting range

AC-3
380 V
400 V
415 V

Rated
operational
current
400 V

Rated short-
circuit current
380 – 415 V

Overload
release

Short-circuit
release

P
kW

I_e
A

I_q
kA

I_r
A



I_{rm}
A



Type
Article no.

Type
Article no.

Complete units PKZ and DILM



0.06	0.21	150 (50) ¹⁾	0.16 – 0.25	3.5	MSC-D-0,25-M7 (...) 281925	MSC-D-0,25-M7 (...) 283154
0.09	0.31	150 (50) ¹⁾	0.25 – 0.4	5.6	MSC-D-0,4-M7 (...) 281926	MSC-D-0,4-M7 (...) 283155
0.12	0.41	150 (50) ¹⁾	0.40 – 0.63	8.82	MSC-D-0,63-M7 (...) 281927	MSC-D-0,63-M7 (...) 283156
0.18	0.6	150 (50) ¹⁾	0.40 – 0.63	8.82	MSC-D-0,63-M7 (...) 281927	MSC-D-0,63-M7 (...) 283156
0.25	0.8	150 (50) ¹⁾	0.63 – 1	14	MSC-D-1-M7 (...) 281929	MSC-D-1-M7 (...) 283158
0.37	1.1	150 (50) ¹⁾	1.00 – 1.6	22.4	MSC-D-1,6-M7 (...) 283140	MSC-D-1,6-M7 (...) 283159
0.55	1.5	150 (50) ¹⁾	1.00 – 1.6	22.4	MSC-D-1,6-M7 (...) 283140	MSC-D-1,6-M7 (...) 283159
0.75	1.9	150 (50) ¹⁾	1.60 – 2.5	35	MSC-D-2,5-M7 (...) 283142	MSC-D-2,5-M7 (...) 283161
1.1	2.6	150 (50) ¹⁾	2.50 – 4	56	MSC-D-4-M7 (...) 283143	MSC-D-4-M7 (...) 283162
1.5	3.6	150 (50) ¹⁾	2.50 – 4	56	MSC-D-4-M7 (...) 283143	MSC-D-4-M7 (...) 283162
2.2	5	150 (50) ¹⁾	4.00 – 6.3	88.2	MSC-D-6,3-M7 (...) 283145	MSC-D-6,3-M7 (...) 283164
3	6.6	150 (50) ¹⁾	6.30 – 10	140	MSC-D-10-M7 (...) 283146	MSC-D-10-M7 (...) 283165
4	8.5	150 (50) ¹⁾	6.30 – 10	140	MSC-D-10-M9 (...) 283147	MSC-D-10-M9 (...) 283166
5.5	11.3	50	8 – 12	168	MSC-D-12-M12 (...) 283148	MSC-D-12-M12 (...) 283167
7.5	16 (15.5) ¹⁾	50	10 – 16	224	-	-
7.5	16	50	10 – 16	224	MSC-D-16-M17 (...) 283150	MSC-D-16-M17 (...) 283168
11	21.7	50	20 – 25	350	MSC-D-25-M25 (...) 283151	MSC-D-25-M25 (...) 283169
15	29.3	50	25 – 32	448	MSC-D-32-M32 (...) 283152	MSC-D-32-M32 (...) 283170

Components PKZM4 and DILM



5.5	11.3	50	10 - 16	224	-	-
7.5	16	50	10 - 16	224	-	-
11	21.7	50	20 - 25	350	-	-
15	29.3	50	25 - 32	448	-	-
18.5	36	50	32 - 40	560	-	-
22	41	50	40 - 50	700	-	-
30	55	50	50 - 58	812	-	-
34	63	50	55 - 65	910	-	-







Direct-on-line starter, 400/415 V

Motor-protective circuit-breaker	Contactor	DOL starter set	Contactor	DOL starter set
	Coordination type "1"	Mechanical connection element + Electrical contact element	Coordination type "2"	Mechanical connection element + Electrical contact element
Type Article no.	Type ³⁾	Type Article no.	Type ³⁾	Type Article no.
PKZM0-0,25 072731	DILM7-...	PKZM0-XD M12 283149	DILM7-...	PKZM0-XD M12 283149
PKZM0-0,4 072732	DILM7-...	PKZM0-XD M12 283149	DILM7-...	PKZM0-XD M12 283149
PKZM0-0,63 072733	DILM7-...	PKZM0-XD M12 283149	DILM7-...	PKZM0-XD M12 283149
PKZM0-0,63 072733	DILM7-...	PKZM0-XD M12 283149	DILM7-...	PKZM0-XD M12 283149
PKZM0-1 072734	DILM7-...	PKZM0-XD M12 283149	DILM7-...	PKZM0-XD M12 283149
PKZM0-1,6 072735	DILM7-...	PKZM0-XD M12 283149	DILM7-...	PKZM0-XD M12 283149
PKZM0-1,6 072735	DILM7-...	PKZM0-XD M12 283149	DILM7-...	PKZM0-XD M12 283149
PKZM0-2,5 072736	DILM7-...	PKZM0-XD M12 283149	DILM7-...	PKZM0-XD M12 283149
PKZM0-4 072737	DILM7-...	PKZM0-XD M12 283149	DILM7-...	PKZM0-XD M12 283149
PKZM0-4 072737	DILM7-...	PKZM0-XD M12 283149	DILM7-...	PKZM0-XD M12 283149
PKZM0-6,3 072738	DILM7-...	PKZM0-XD M12 283149	DILM7-...	PKZM0-XD M12 283149
PKZM0-10 072739	DILM7-...	PKZM0-XD M12 283149	DILM17-...	PKZM0-XD M32 283153
PKZM0-10 072739	DILM9-...	PKZM0-XD M12 283149	DILM17-...	PKZM0-XD M32 283153
PKZM0-12 278486	DILM12-...	PKZM0-XD M12 283149	DILM17-...	PKZM0-XD M32 283153
PKZM0-16 046938	DILM15-...	PKZM0-XD M12 283149	DILM17-...	PKZM0-XD M32 283153
PKZM0-16 046938	DILM17-...	PKZM0-XD M32 283153	DILM17-...	PKZM0-XD M32 283153
PKZM0-25 046989	DILM25-...	PKZM0-XD M32 283153	DILM25-...	PKZM0-XD M32 283153
PKZM0-32 278489	DILM32-...	PKZM0-XD M32 283153	DILM32-...	PKZM0-XD M32 283153
PKZM4-16 222350	DIL M17-...	-	DIL M17-...	-
PKZM4-16 222350	DIL M17-...	-	DIL M17-...	-
PKZM4-25 222352	DIL M25-...	-	DIL M25-...	-
PKZM4-32 222353	DIL M32-...	-	DIL M32-...	-
PKZM4-40 222354	DIL M40	-	DIL M40	-
PKZM4-50 222355	DIL M50	-	DIL M50	-
PKZM4-58 222394	DIL M65	-	DIL M65	-
PKZM4-63 222413	DIL M65	-	DIL M65	-

Notes

The direct-on-line starters (complete units) consist of a PKZM0 motor-protective circuit-breaker and a DILM contactor.
Up to 15.5 A, starters are mounted without adapter plates, with only the motor-protective circuit-breaker being secured to the top-hat rail. The contactors receive their mechanical hold via a mechanical connection module.
From 16 A, motor-protective circuit-breakers and contactors are mounted on top-hat-rail adapter plates. The connection of the main contacts between PKZ and contactor is effected via an electrical contact module.

Reversing starter 400/415 V

	Motor data					Setting range		Motor starter Coordination type "1"	
	AC-3 380 V 400 V 415 V	Rated operational current 400 V	Rated short- circuit current 380 – 415 V	Overload release	Short-circuit releases	Actuating voltage 230 V 50 Hz 240 V 60 Hz	Actuating voltage 24 V DC	Type Article no.	Type Article no.
	P kW	I_e A	I_q kA	I_r A 	I_{rm} A 				
Complete units PKZ and DILM  	0.06	0.21	150 (50) ¹⁾	0.16 – 0.25	3.5	MSC-R-0,25-M7 (...) 283171	MSC-R-0,25-M7 (...) 283190		
	0.09	0.31	150 (50) ¹⁾	0.25 – 0.4	5.6	MSC-R-0,4-M7 (...) 283172	MSC-R-0,4-M7 (...) 283191		
	0.12	0.41	150 (50) ¹⁾	0.40 – 0.63	8.82	MSC-R-0,63-M7 (...) 283173	MSC-R-0,63-M7 (...) 283192		
	0.18	0.6	150 (50) ¹⁾	0.40 – 0.63	8.82	MSC-R-0,63-M7 (...) 283173	MSC-R-0,63-M7 (...) 283192		
	0.25	0.8	150 (50) ¹⁾	0.63 – 1	14	MSC-R-1-M7 (...) 283175	MSC-R-1-M7 (...) 283194		
	0.37	1.1	150 (50) ¹⁾	1.00 – 1.6	22.4	MSC-R-1,6-M7 (...) 283176	MSC-R-1,6-M7 (...) 283195		
	0.55	1.5	150 (50) ¹⁾	1.00 – 1.6	22.4	MSC-R-1,6-M7 (...) 283176	MSC-R-1,6-M7 (...) 283195		
	0.75	1.9	150 (50) ¹⁾	1.60 – 2.5	35	MSC-R-2,5-M7 (...) 283178	MSC-R-2,5-M7 (...) 283197		
	1.1	2.6	150 (50) ¹⁾	2.50 – 4	56	MSC-R-4-M7 (...) 283179	MSC-R-4-M7 (...) 283198		
	1.5	3.6	150 (50) ¹⁾	2.50 – 4	56	MSC-R-4-M7 (...) 283179	MSC-R-4-M7 (...) 283198		
	2.2	5	150 (50) ¹⁾	4.00 – 6.3	88.2	MSC-R-6,3-M7 (...) 283181	MSC-R-6,3-M7 (...) 283200		
	3	6.6	150 (50) ¹⁾	6.30 – 10	140	MSC-R-10-M7 (...) 283182	MSC-R-10-M7 (...) 283201		
	4	8.5	150 (50) ¹⁾	6.30 – 10	140	MSC-R-10-M9 (...) 283183	MSC-R-10-M9 (...) 283202		
	5.5	11.3	50	8 – 12	168	MSC-R-12-M12 (...) 283184	MSC-R-12-M12 (...) 283203		
	7.5	16 (15.5) ²⁾	50	10 - 16	224	-	-		
7.5	16	50	10 – 16	224	MSC-R-16-M17 (...) 283186	MSC-R-16-M17 (...) 283204			
11	21.7	50	20 – 25	350	MSC-R-25-M25 (...) 283187	MSC-R-25-M25 (...) 283205			
15	29.3	50	25 – 32	448	MSC-R-32-M32 (...) 283188	MSC-R-32-M32 (...) 283206			
Components PKZM4 and DILM  	5.5	11.3	50	10 - 16	224	-	-		
	7.5	16	50	10 - 16	224	-	-		
	11	21.7	50	20 - 25	350	-	-		
	15	29.3	50	25 - 32	448	-	-		
	18.5	36	50	32 - 40	560	-	-		
	22	41	50	40 - 50	700	-	-		
	30	55	50	50 - 58	812	-	-		
34	63	50	55 - 65	910	-	-			

Reversing starter 400/415 V

Motor-protective circuit-breakers	Contactor	DOL starter set	Contactor	DOL starter set
	Coordination type "1"	Mechanical connection element + Electrical contact element	Coordination type "2"	Mechanischer connection element + Electrical contact element
Type Article no.	Type ³⁾	Type Article no.	Type ³⁾	Type Article no.
PKZM0-0,25 072731	2 X DILM7-01	PKZM0-XR M12 283185	2 x DILM7-01	PKZM0-XR M12 283185
PKZM0-0,4 072732	2 x DILM7-01	PKZM0-XR M12 283185	2 x DILM7-01	PKZM0-XR M12 283185
PKZM0-0,63 072733	2 x DILM7-01	PKZM0-XR M12 283185	2 x DILM7-01	PKZM0-XR M12 283185
PKZM0-0,63 072733	2 x DILM7-01	PKZM0-XR M12 283185	2 x DILM7-01	PKZM0-XR M12 283185
PKZM0-1 072734	2 x DILM7-01	PKZM0-XR M12 283185	2 x DILM7-01	PKZM0-XR M12 283185
PKZM0-1,6 072735	2 x DILM7-01	PKZM0-XR M12 283185	2 x DILM7-01	PKZM0-XR M12 283185
PKZM0-1,6 072735	2 x DILM7-01	PKZM0-XR M12 283185	2 x DILM7-01	PKZM0-XR M12 283185
PKZM0-2,5 072736	2 x DILM7-01	PKZM0-XR M12 283185	2 x DILM7-01	PKZM0-XR M12 283185
PKZM0-4 072737	2 x DILM7-01	PKZM0-XR M12 283185	2 x DILM7-01	PKZM0-XR M12 283185
PKZM0-4 072737	2 x DILM7-01	PKZM0-XR M12 283185	2 x DILM7-01	PKZM0-XR M12 283185
PKZM0-6,3 072738	2 x DILM7-01	PKZM0-XR M12 283185	2 x DILM7-01	PKZM0-XR M12 283185
PKZM0-10 072739	2 x DILM7-01	PKZM0-XR M12 283185	2 x DILM17-01	PKZM0-XR M32 283189
PKZM0-10 072739	2 x DILM9-01	PKZM0-XR M12 283185	2 x DILM17-01	PKZM0-XR M32 283189
PKZM0-12 278486	2 x DILM12-01	PKZM0-XR M12 283185	2 x DILM17-01	PKZM0-XR M32 283189
PKZM0-16 046938	2 x DILM15-01	PKZM0-XR M12 283185	2 x DILM17-01	PKZM0-XR M32 283189
PKZM0-16 046938	2 x DILM17-01	PKZM0-XR M32 283189	2 x DILM17-01	PKZM0-XR M32 283189
PKZM0-25 046989	2 x DILM25-01	PKZM0-XR M32 283189	2 x DILM25-01	PKZM0-XR M32 283189
PKZM0-32 278489	2 x DILM32-01	PKZM0-XR M32 283189	2 x DILM32-01	PKZM0-XR M32 283189
PKZM4-16 222350	2 X DIL M17-..	-	2 X DIL M17-..	-
PKZM4-16 222350	2 X DIL M17-..	-	2 X DIL M17-..	-
PKZM4-25 222352	2 X DIL M25-..	-	2 X DIL M25-..	-
PKZM4-32 222353	2 X DIL M32-..	-	2 X DIL M32-..	-
PKZM4-40 222354	2 X DIL M40	-	2 X DIL M40	-
PKZM4-50 222355	2 X DIL M50	-	2 X DIL M50	-
PKZM4-58 222394	2 X DIL M65	-	2 X DIL M65	-
PKZM4-63 222413	2 X DIL M65	-	2 X DIL M65	-

Notes

The reversing starters (complete units) consist of a PKZM0 motor-protective circuit-breaker and two DILM contactors. Up to 12 A, starters are mounted without adapter plates, with only the motor-protective circuit-breaker being secured to the top-hat rail. The contactors receive their mechanical hold via a mechanical connection module. From 16 A, motor-protective circuit-breakers and contactors are mounted on top-hat-rail adapter plates. The connection of the main contacts between PKZ and contactor is effected via an electrical contact module. Complete units with mechanical interlock, starters up to 12 A also with electrical interlock.

³⁾ Please find the order number in the Industrial Switchgear main catalogue to ILM 1000. Permitted voltage.

Reversing combinations

Rated operational current AC-3 380 V 400 V	Max. three-phase motor rating at 50-60 Hz						Type Article no.
	AC-3 220 V 230 V	380 V 400 V	660 V 690 V	AC-4 220 V 230 V	380 V 400 V	660 V 690 V	
I_e A	P kW	P kW	P kW	P kW	P kW	P kW	
7	2.2	3	3.5	1	2.4	2.9	DIULM7/21 (230V50HZ) 278061
9	2.5	4	4.5	1.5	2.5	3.6	DIULM9/21 (230V50HZ) 278086
12	3.5	5.5	6.5	2	3	4.4	DIULM12/21 (230V50HZ) 278111
18	5	7.5	11	2.5	4.5	6.5	DIULM17/21 (230V50HZ) 278136
25	7.5	11	14	3.5	6	8.5	DIULM25/21 (230V50HZ) 278161
32	10	15	17	4	7	10	DIULM32/21 (230V50HZ) 278186
40	12.5	18.5	23	5	9	12	DIULM40/11 (230V50HZ) 278211
50	15.5	22	30	6	10	14	DIULM50/11 (230V50HZ) 278236
65	20	30	35	7	12	17	DIULM65/11 (230V50HZ) 278261
80	25	37	63	12	20	28	DIUL M80/11 (230V 50Hz) 239799
95	30	45	75	15	26	36	DIUL M95/11 (230V 50Hz) 239841
115	37	55	105	17	30	42	DIUL M115/11 (RAC240) 239862
150	48	75	125	20	34	48	DIUL M150/11 (RAC240) 239880

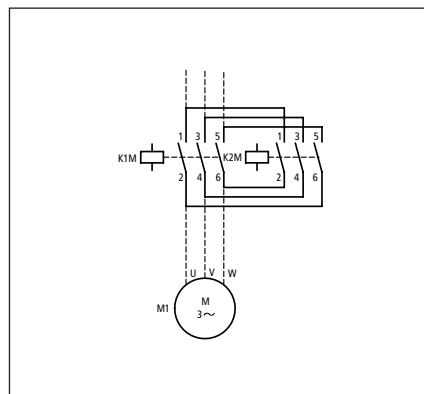
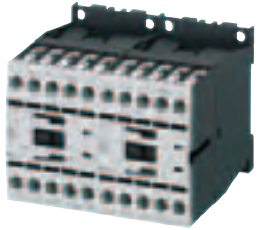

Reversing combinations

Individual combination components		Free auxiliary switch M = Make		Mechanical interlock
Contactor K1M	Contactor K2M	K1M	K2M	
Type	Type			
DILM7-01 + DILA-XHI20	DILM7-01 + DILA-XHI20	1 M	1 M	+
DILM9-01 + DILA-XHI20	DILM9-01 + DILA-XHI20	1 M	1 M	+
DILM12-01 + DILA-XHI20	DILM12-01 + DILA-XHI20	1 M	1 M	+
DILM17-01 + DILA-XHI20	DILM17-01 + DILA-XHI20	1 M	1 M	+
DILM25-01 + DILA-XHI20	DILM25-01 + DILA-XHI20	1 M	1 M	+
DILM32-01 + DILA-XHI20	DILM32-01 + DILA-XHI20	1 M	1 M	+
DILM40 + DILM150-XHI11	DILM40 + DILM150-XHI11	-	-	+
DILM50 + DILM150-XHI11	DILM50 + DILM150-XHI11	-	-	+
DILM65 + DILM150-XHI11	DILM65 + DILM150-XHI11	-	-	+
DIL M80 + DIL M150-XHI11	DIL M80 + DIL M150-XHI11	-	-	+
DIL M95 + DIL M150-XHI11	DIL M95 + DIL M150-XHI11	-	-	+
DIL M115 + DIL M150-XHI11	DIL M115 + DIL M150-XHI11	-	-	+
DIL M150 + DIL M150-XHI11	DIL M150 + DIL M150-XHI11	-	-	+

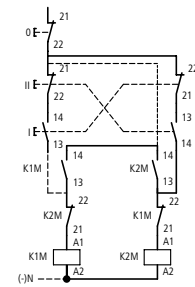
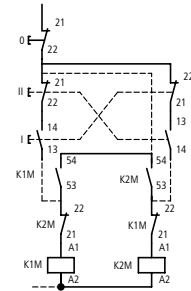

Star-delta combinations

Rated operational current AC-3 380 V 400 V	Max. three-phase motor rating at 50-60 Hz				Switchover time up to s	Type Article no.
	AC-3 220 V 230 V	380 V 400 V	500 V	660 V 690 V		
I_e A	P kW	P kW	P kW	P kW	s	
12	3	5.5	5.5	5.5	20	SDAINLM12 (230V50HZ) 278286
16	4	7.5	7.5	7.5	20	SDAINLM16 (230V50HZ) 278311
22	5.5	11	11	11	20	SDAINLM22 (230V50HZ) 278336
30	7.5	15	18.5	18.5	20	SDAINLM30 (230V50HZ) 278361
45	11	22	30	22	20	SDAINLM45 (230V50HZ) 278386
55	15	30	37	30	20	SDAINLM55 (230V50HZ) 278411
70	18.5	37	45	37	20	SDAINLM70 (230V50HZ) 239895
90	22	45	55	45	20	SDAINLM90 (230V50HZ) 239937
115	30	55	75	55	20	SDAINLM115 (230V50HZ) 239963
140	37	75	90	90	20	SDAINLM140 (230V50HZ) 240009
165	45	90	110	132	20	SDAINLM165 (230V50HZ) 240035
200	55	110	132	160	20	SDAINLM200 (RAC240) 240060
260	75	132	160	200	20	SDAINLM260 (RAC240) 240078

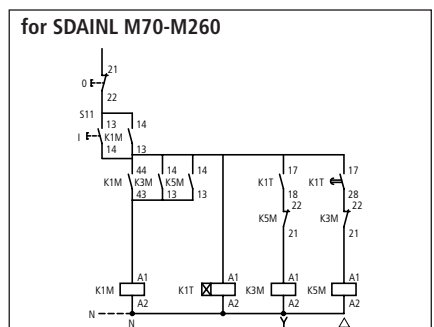
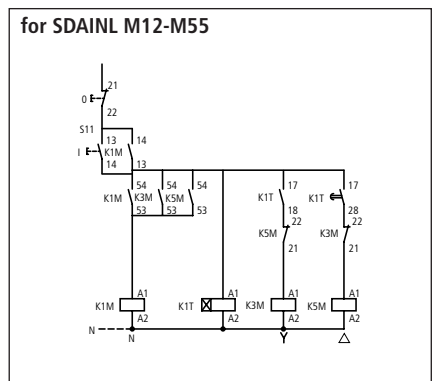
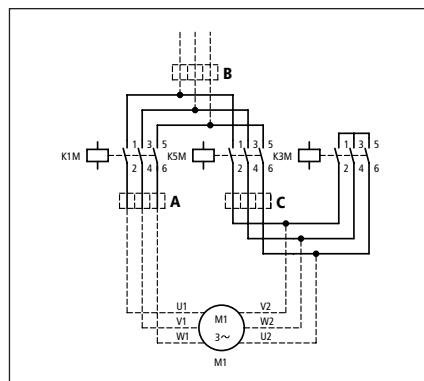
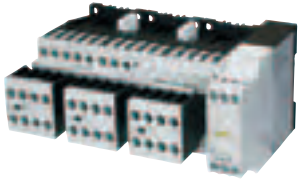

Star-delta combinations

Individual combination components				Free auxiliary switch B = Break M = Make		
Mains contactor	Delta contactor	Star contactor	Timing relay	K1M	K3M	K5M
K1M Type	K5M Type	K3M Type	Type			
DILM7-10 + DILA-XHI20	DILM7-01 + DILA-XHI20	DILM7-01 + DILA-XHI20	ETR4-51	1 M	1 M	1 M
DILM9-10 + DILA-XHI20	DILM9-01 + DILA-XHI20	DILM9-01 + DILA-XHI20	ETR4-51	1 M	1 M	1 M
DILM12-10 + DILA-XHI20	DILM12-01 + DILA-XHI20	DILM12-01 + DILA-XHI20	ETR4-51	1 M	1 M	1 M
DILM17-10 + DILA-XHI20	DILM17-01 + DILA-XHI20	DILM17-01 + DILA-XHI20	ETR4-51	1 M	1 M	1 M
DILM25-10 + DILA-XHI20	DILM25-01 + DILA-XHI20	DILM17-01 + DILA-XHI20	ETR4-51	1 M	1 M	1 M
DILM32-10 + DILA-XHI20	DILM32-01 + DILA-XHI20	DILM25-01 + DILA-XHI20	ETR4-51	1 M	1 M	1 M
DIL M40 + DIL M150-XHI31	DIL M40 + DIL M150-XHI11	DIL M40 + DIL M150-XHI11	ETR4-51	1 B 1M	-	-
DIL M50 + DIL M150-XHI31	DIL M50 + DIL M150-XHI11	DIL M40 + DIL M150-XHI11	ETR4-51	1 B 1M	-	-
DIL M65 + DIL M150-XHI31	DIL M65 + DIL M150-XHI11	DIL M40 + DIL M150-XHI11	ETR4-51	1 B 1M	-	-
DIL M80 + DIL M150-XHI31	DIL M80 + DIL M150-XHI11	DIL M50 + DIL M150-XHI11	ETR4-51	1 B 1M	-	-
DIL M95 + DIL M150-XHI31	DIL M95 + DIL M150-XHI11	DIL M65 + DIL M150-XHI11	ETR4-51	1 B 1M	-	-
DIL M115 + DIL M150-XHI31	DIL M115 + DIL M150-XHI11	DIL M80 + DIL M150-XHI11	ETR4-51	1 B 1M	-	-
DIL M150 + DIL M150-XHI31	DIL M150 + DIL M150-XHI11	DIL M80 + DIL M150-XHI11	ETR4-51	1 B 1M	-	-

Overload relay settings

A: $I_N \times 0.58$
Protection of the motor in Y and Δ configuration

Starting

≤ 15 s

B: $I_N \times 1$
In Y configuration only conditional motor protection

15-40 s

C: $I_N \times 0.58$
No motor protection in Y configuration

> 40 s

Timing relay setting to approx. 10 s

Main circuit:

Depending on the aspired co-ordination type "1" or "2", it is necessary to verify if the fusing and the incomer to the mains and delta contactor can be used together, or if they must be used separately.

Busbar adapter

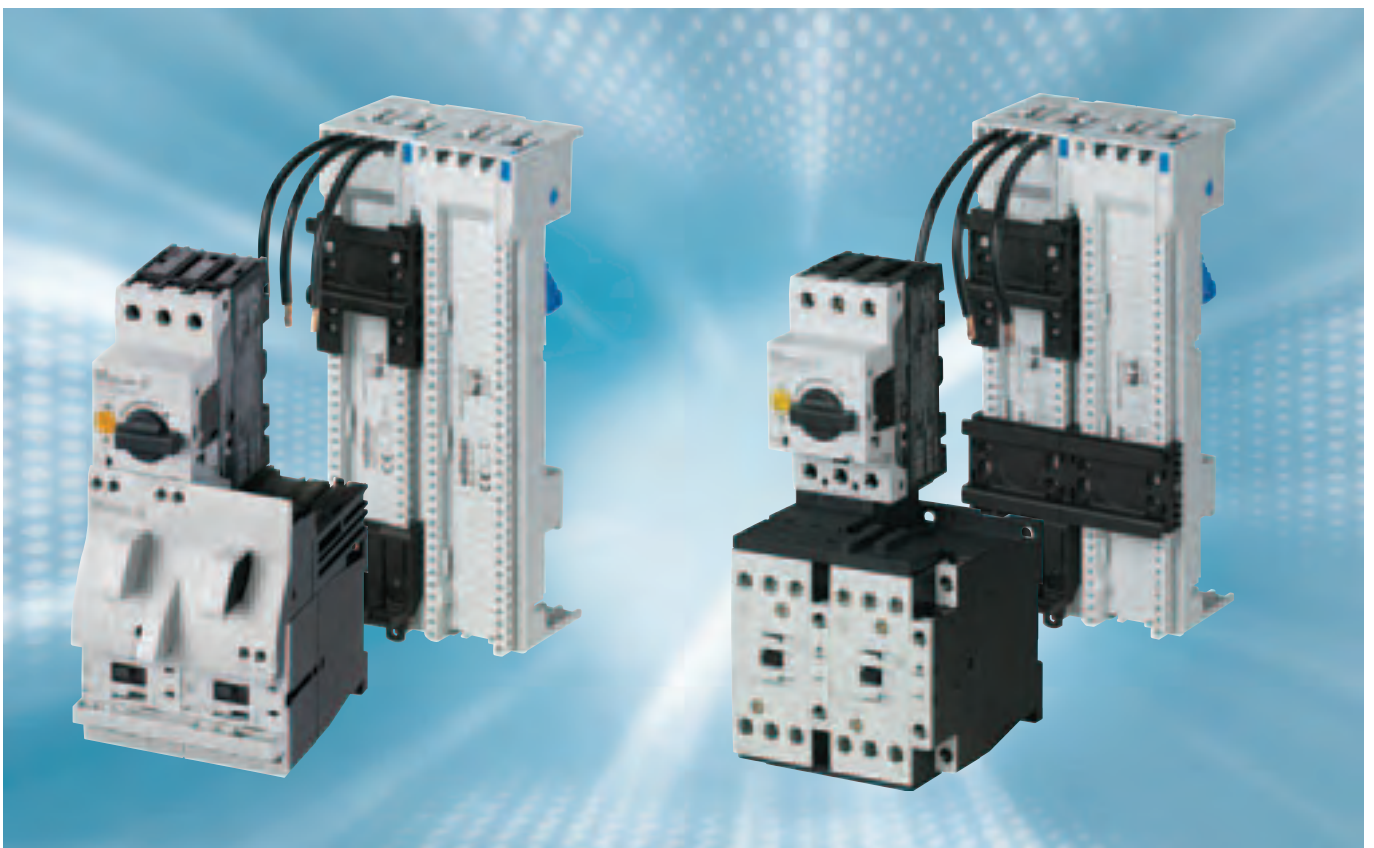

Busbar adapter, 3-pole ¹									
wöhner	Rated operational voltage	Rated operational current	Conductor cross-section	Adapter width	Adapter length	Mounting rail	For use with	Wöhner EQUES Easy Connector	Notes
Version	U_e V	I_e A		mm	mm			Order no.	Electrical connections
Busbar adapter 25 A	690	25	AWG 12 (4 mm ²)	45	200	1	PKZM0 + DIL M 7 contactor DIL M 9 contactor DIL M 12 contactor DIL M 15 contactor	32450	PKZM0 and contactor DIL M7..M9..M12..M15 via PKZM0-XDM12
	690	25	AWG 12 (4 mm ²)	90	200	1	PKZM0 + 2 x DIL M 7-01contactor 2 x DIL M 9-01contactor 2 x DIL M 12-01contactor	32452	PKZM0 and 2 x contactor DIL M 7..M9..M12 via PKZM0-XRM12
Busbar adapter 32 A	690	32	AWG 10 (6 mm ²)	45	200	2	PKZM0 + DIL M 17 contactor DIL M 25 contactor DIL M 32 contactor	32451	PKZM0 and contactor DIL M17..M25..M32 via PKZM0-XDM32
	690	32	AWG 10 (6 mm ²)	90	200	2	PKZM0 + 2 x DIL M 17-01contactor 2 x DIL M 25-01contactor 2 x DIL M 32-01contactor	32453	PKZM0 and 2 x contactor DIL M17..M25..M32 via PKZM0-XRM32
Busbar adapter 63 A	690	40	AWG 8 (10 mm ²)	72	260	2	PKZ2 + DIL M 7 contactor DIL M 9 contactor DIL M 12 contactor DIL M 17 contactor DIL M 25 contactor DIL M 32 contactor DIL M 40 contactor	32463	PKZ2 and contactor DIL M7..M9..M12 via flexible connectors MVS-LB0-00M-G (AWG 12) DIL M17..M25..M32 via flexible connectors MVS-LB0-0M-G (AWG 10)
	690	40	AWG 8 (10 mm ²)	72	200	1	PKZ2	32457	
	690	63	AWG 8 (10 mm ²)	54	260	2	PKZM4 + DIL M 17 contactor DIL M 25 contactor DIL M 32 contactor DIL M 40 contactor DIL M 50 contactor DIL M 65 contactor	32460	PKZM4 and contactor DIL M 17..M25..M32 via flexible connectors MVS-LB0-0M-G (AWG 10) DIL M40..M50..M65 via contact module PKZM4-XM65 DE
	690	63	AWG 8 (10 mm ²)	54	200	1	PKZM4	32454	
Side module plug-in on both sides				9	200	4		32963	Can be grouped on AD... for expansion of the mounting width
Connection elements								32954	

¹ Can be used in all 60 mm systems. Suitable for 5 and 10 mm rail thickness' via combination foot

² Busbar adapter without electrical contacting

³ Mounting by snap fitting onto the voltage-free busbar

Moeller addresses worldwide:
www.moeller.net/address
E-Mail: info@moeller.net

© 2005 by Moeller GmbH
Subject to alterations
W1200+2100-7548GB MDS/Eb 03/05
Printed in the Federal Republic of Germany (03/05)
Article No.: 284765



Xtra Combinations

Xtra Combinations from Moeller offers a range of products and services, enabling the best possible combination options for switching, protection and control in power distribution and automation.

Using Xtra Combinations enables you to find more efficient solutions for your tasks while optimising the economic viability of your machines and systems.

It provides:

- flexibility and simplicity
- great system availability
- the highest level of safety

All the products can be easily combined with one another mechanically, electrically and digitally, enabling you to arrive at flexible and stylish solutions tailored to your application – quickly, efficiently and cost-effectively.

The products are proven and of such excellent quality that they ensure a high level of operational continuity, allowing you to achieve optimum safety for your personnel, machinery, installations and buildings.

Thanks to our state-of-the-art logistics operation, our comprehensive dealer network and our highly motivated service personnel in 80 countries around the world, you can count on Moeller and our products every time. Challenge us! We are looking forward to it!

MOELLER



Think future. Switch to green.

For Immediate Delivery call KMParts.com at (866) 595-9616