

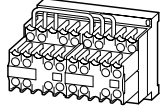

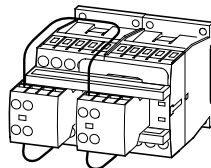

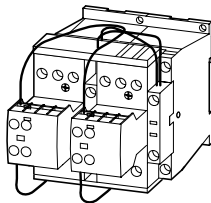























Rated operational current	Max. rating for three-phase motors, 50 – 60 Hz						Part no. Article no.	Price see price list	Std. pack
	AC-3		AC-4						
380 V 400 V 380 V 400 V	220 V 230 V	380 V 400 V	660 V 690 V	220 V 230 V	380 V 400 V	660 V 690 V			
I_e	P	P	P	P	P	P			
A	kW	kW	kW	kW	kW	kW			

DIUL reversing combinations

AC operation

	9	2.2	4	4	1.5	3	3	DIULEM/21/MV(230V50HZ) 051849	1 off
	9	2.2	4	4	1.5	3	3	DIULEM/21/MV-G(24VDC) 214655	1 off
	7	2.2	3	3.5	1	2.2	2.9	DIULM7/21(230V50HZ) 278061	1 off
	7	2.2	3	3.5	1	2.2	2.9	DIULM7/21(24VDC) 107021	1 off
	9	2.5	4	4.5	1.5	2.5	3.6	DIULM9/21(230V50HZ) 278086	1 off
	9	2.5	4	4.5	1.5	2.5	3.6	DIULM9/21(24VDC) 107022	1 off
	12	3.5	5.5	6.5	2	3	4.4	DIULM12/21(230V50HZ) 278111	1 off
	12	3.5	5.5	6.5	2	3	4.4	DIULM12/21(24VDC) 107023	1 off
	18	5	7.5	11	2.5	4.5	6.5	DIULM17/21(230V50HZ) 278136	1 off
	18	5	7.5	11	2.5	4.5	6.5	DIULM17/21(RDC24) 107024	1 off
	25	7.5	11	14	3.5	6	8.5	DIULM25/21(230V50HZ) 278161	1 off
	25	7.5	11	14	3.5	6	8.5	DIULM25/21(RDC24) 107025	1 off
	32	10	15	17	4	7	10	DIULM32/21(230V50HZ) 278186	1 off
	32	10	15	17	4	7	10	DIULM32/21(RDC24) 107026	1 off
	40	12.5	18.5	23	5	9	12	DIULM40/11(230V50HZ) 278211	1 off
50	15.5	22	30	6	10	14	DIULM50/11(230V50HZ) 278236	1 off	
65	20	30	35	7	12	17	DIULM65/11(230V50HZ) 278261	1 off	

Individual components of the combination	Spare auxiliary contacts	Notes
Contactor Q11	Contactor Q12	Q11 Q12 Mechanical interlock
Part no.	Part no.	

DILEM-10 + 11DILEM	DILEM-10 + 11DILEM			+
DILEM-10-G + 11DILEM	DILEM-10-G + 11DILEM			+
DILM7-01 + DILA-XHI20	DILM7-01 + DILA-XHI20			+
DILM7-01 + DILA-XHI20	DILM7-01 + DILA-XHI20			+
DILM9-01 + DILA-XHI20	DILM9-01 + DILA-XHI20			+
DILM9-01 + DILA-XHI20	DILM9-01 + DILA-XHI20			+
DILM12-01 + DILA-XHI20	DILM12-01 + DILA-XHI20			+
DILM12-01 + DILA-XHI20	DILM12-01 + DILA-XHI20			+
DILM17-01 + DILA-XHI20	DILM17-01 + DILA-XHI20			+
DILM17-01 + DILA-XHI20	DILM17-01 + DILA-XHI20			+
DILM25-01 + DILA-XHI20	DILM25-01 + DILA-XHI20			+
DILM25-01 + DILA-XHI20	DILM25-01 + DILA-XHI20			+
DILM32-01 + DILA-XHI20	DILM32-01 + DILA-XHI20			+
DILM32-01 + DILA-XHI20	DILM32-01 + DILA-XHI20			+
DILM40 + DILM150-XHI11	DILM40 + DILM150-XHI11	-	-	+
DILM50 + DILM150-XHI11	DILM50 + DILM150-XHI11	-	-	+
DILM65 + DILM150-XHI11	DILM65 + DILM150-XHI11	-	-	+

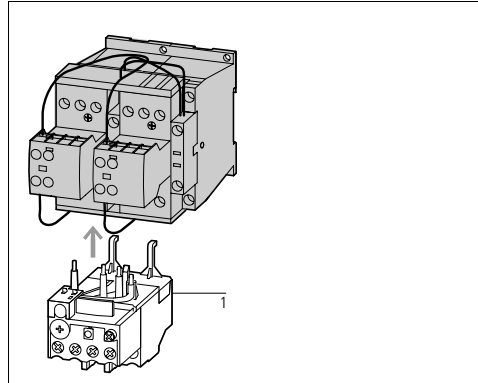
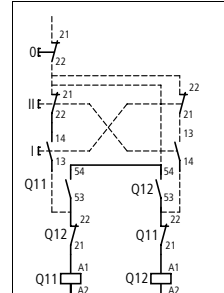
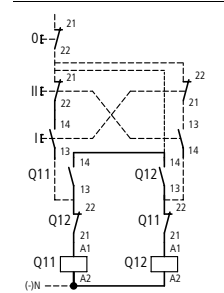

Accessories
1 Overload relay → 6/7
Accessories → 5/42

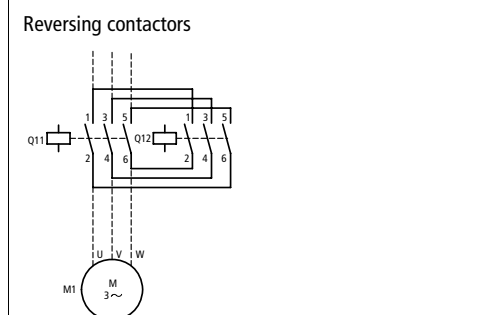

DIULM7/21 to DIULM150/11 with mechanical interlock
DIULM80/11 to DIULM150/11 on mounting plates